RURAL ROADS ACTIVE MANAGEMENT PROGRAM (RRAMP)

For the municipalities located in
the Lake Champlain Watershed of New York



CHAMPLAIN WATERSHED
IMPROVEMENT COALITION OF NEW YORK
CLINTON | ESSEX | FRANKLIN | WARREN | WASHINGTON | COUNTIES



*A Best Management Practices (BMP) publication
of the Champlain Watershed Improvement Coalition of New York (CWICNY)*

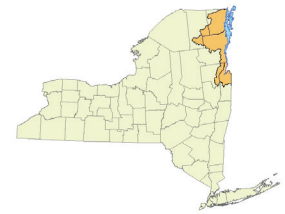

**Lake Champlain Basin
in New York State**

Counties of Lake Champlain Basin in New York

Principles of Rural Roads Active Management Program

1. Get water off the road quickly and avoid having water run lengthwise down the road.
2. Stabilize and revegetate disturbed area in and/or near ditches, culverts, banks, inlets and outlets immediately
3. Divert as much runoff a possible away from surface waters into vegetated areas
4. Good maintenance saves \$\$\$ by decreasing road problems and preventing untimely repairs.
5. Good maintenance and infrastructure reduces susceptibility to flash flood damage.

TABLE OF CONTENTS

Introduction	1	Ditches	17
About the Lake Champlain Watershed of New York	1	Ditch Assessment Checklist.....	17
Local RRAMP Partners	1	Ditch Profiling and Grading.....	17
RRAMP Program Mission.....	1	Ditch Linings.....	18
RRAMP Program Goals.....	2	Grass-lined Ditch*.....	18
About Best Management Practices.....	2	Stone-lined Ditch*.....	18
Purpose of this Manual.....	2	Ditch Types.....	18
Problems Caused by Soil Erosion & Sedimentation.....	2	Diversion Ditch*.....	19
Rural Roads Active Management Checklist.....	3	Diversion Berm*.....	19
Road Surfaces	4	Velocity Controls*.....	19
Signs of Distress in Unpaved Roads.....	4	Stone Check Dams*.....	19
Common Surface Deteriorations.....	4	Log and Brush Check Dams.....	20
Common Surface Deformations.....	4	Cleaning and Maintenance.....	21
Road Crown & Profile*.....	6	Matrix of BMPs for Ditch Maintenance*.....	21
Shoulders.....	6	Ditch Lining Materials*.....	22
Unpaved to Paved Considerations.....	7	Culverts	23
Unpaved Roads Surface Evaluation BMPs for Maintenance Work*.....	7	Culvert Considerations.....	23
Surface Materials.....	9	Storm Culvert Recommendations*.....	24
Disposal of Excess Materials.....	9	Culvert Profile and Cross Section*.....	24
Erosion and Sediment Control	10	Installation & Replacement*.....	24
Erosion.....	10	Aquatic Critter Friendly Culverts*.....	26
Sedimentation.....	10	Intersections of Public Roads with Private Roads/Drives.....	26
Types of Erosion and the Erosion Process*.....	10	Headers or Headwalls*.....	27
Methods of Erosion Control.....	11	Cleaning & Maintenance.....	27
Details of Erosion Processes.....	12	Special Environmental Considerations for Culvert Installation.....	28
Temporary Erosion and Sedimentation Control....	13	Culvert Maintenance*.....	28
The Erosion and Sediment Control Plan (ESCP)....	13	Outlet Protection	31
Principles of a Soil Erosion and Water Pollution Control Plan.....	13	Structural Outlet Protection.....	31
Spill Prevention.....	15	Turnouts*.....	31
Project Plan Development.....	15	Rock Apron*.....	32
Erosion Control Overview*.....	16	Riprap Conveyance Channel*.....	33
		Riprap Revetment*.....	33
		Splash/Plunge Pools.....	34

TABLE OF CONTENTS

Splash/Plunge Pool*	34	NY Champlain Basin	
Plunge Pool*	34	Climate Considerations	48
Splash/Plunge Pool Capacity Requirements*	34	Salting and Deicing	48
Non-structural Outlet Protection	35	Overview of Deicing Agents	48
Matrix of Outlet Protection BMPs*	35	Best Practices for Disposal of Snow	49
Bank Stabilization	36	Location, Design, Operational	
Vegetation- Seeding	36	BMPs for Snow Dumps	50
Hydroseeding*	36	Deicing Agents	50
Surface Roughening*	37	Road Conditions	51
Matrix of Bank Stabilization BMPs*	37	Travel Corridor Stewardship	52
Vegetation – Shrubs & Trees	38	Wildlife Friendly Rural Roads BMPs	52
Live Fascines/Wattles/Bundles*	38	Beaver Baffle*	53
Live Stakes*	39	“Beaver Reliever”	53
Brushlayering*	39	Vegetation Management	54
Sprigs/Plugs*	39	Aesthetics*	55
Grading Techniques*	40	Stewardship of Intrinsic Cultural	
Structures—Walls	40	& Regional Resources	55
Gabion Wall*	41	Important Resources for Stewardship BMPs	57
Log or Timber Crib*	41	Resources	58
Structures – Revetment Systems	42	SWCD Contact Information*	58
Riprap Revetment*	42	Local & Regional Organizations*	59
Combination of Techniques	42	Emergency Contacts*	61
Live Cribwall*	43	Additional Information	62
Vegetated Gabion	43	Glossary	63
Vegetated Rock Wall*	44		
Vegetated Riprap/Joint Planting*	44		
Geogrid*	44		
Erosion Control Mats & Blankets	45		
Jute Matting*	45		
Matting Installation*	45		
Additional Techniques	46		
Buffer Zone*	46		
Level Spreader*	47		
Waterbar*	47		

Rural Roads Active Management Program
RRAMP

For municipalities located in the
Lake Champlain Watershed of New York

***Partnering for Natural Resources
Protection and Resilient Travel Corridors***

***A Best Management Practices (BMP) publication
of the Champlain Watershed Improvement Coalition of New York (CWICNY)***

March 2014

***Funding for the development of New York's Lake Champlain RRAMP
was provided by the Lake Champlain Basin Program***

<http://cwicny.org/rramp.php>

The Rural Roads Active Management Program was developed by the Champlain Watershed Improvement Coalition of New York (CWICNY).

Project Coordinator:

Drew Snell
Program Development

RRAMP Manual Editor:

Susan Day Fuller
Fuller Communications
Mountain View New York

Project Consultant:

Jim Lieberum, CPESC
District Manager
County Hazard Mitigation Coordinator
Warren County Soil and Water District

Contents:

Drawn, with permission, from:

The Vermont Better Backroads Manual

A publication of the George D. Aiken & Northern Vermont Resource Conservation and Development (RC&D) Councils, 2009

Additional content has been adapted from:

Publications of the Cornell Local Roads Program

<http://www.clrp.cornell.edu/>

The Massachusetts Unpaved Roads BMP Manual

Prepared by the Berkshire Regional Planning Commission

Maine DOT *Best Management Practices for Erosion and Sedimentation Control*

Illustrations

Provided by: VT Better Back Roads Program

Jarrold H. Becker

Business Manager

Northern Vermont Resource Conservation & Development Council

The information in this manual has been compiled from a number of reputable sources and reviewed for technical validity. It has not been certified for engineering integrity. This manual provides guidance on erosion control for rural roads, not definitive design specifications. Individual site conditions (i.e. soils, grades, proximity to water bodies, rates of flow, peak discharges, etc.) must be considered when projects are designed. The services of a professional engineer may be required in some instances.

For further assistance, including information on erosion assessment, and planning grants, additional publications, and on-site assistance, please contact any of the CWICNY partners, listed in the Resource section of this manual.

About the Lake Champlain Watershed of New York

Lake Champlain covers an area of 435 square miles (excluding the areas of more than 50 islands) within an 8,234-square-mile drainage basin in New York State, Vermont and Quebec. The Lake Champlain Watershed in New York encompasses 37 percent of the Lake's drainage basin. The basin's watershed is the area of land where all of the water that is present in lakes, rivers, streams and other wetlands drains off and eventually flows into Lake Champlain.

A healthy Lake Champlain is integral to the region's quality of life. In addition to its uses for sports fishing, hunting, and recreation, Lake Champlain is the major source of drinking water for nearly 200,000 people in over 20 towns and cities in New York, Vermont, and Quebec. The watershed's natural and social resources attract business, tourism, and a thriving cultural scene. Partnerships throughout the basin are working to protect and restore Lake Champlain and its watershed.

About the Champlain Watershed Improvement Coalition of New York (CWICNY)

Since its formation in 2001, the Champlain Watershed Improvement Coalition, Inc. (CWICNY) has become a regional leader in developing and coordinating successful conservation projects on the New York side of the Lake Champlain Basin.

The Mission of CWICNY is to provide a coordinated effort to improve water quality and other natural resources within the New York Lake Champlain counties through project implementation. The goal of CWICNY, its member organizations, and its cooperating partners is to reduce phosphorus loading to Lake Champlain through the implementation of numerous projects and practices throughout the New York side of the Lake Champlain watershed. These reductions will have a long-term positive impact upon the water quality and ecology of the lake and its many tributaries.

Roadside erosion is a highly recognized source of sedimentation throughout the watershed. Through the continuous processes of disturbance and precipitation, soil particles mobilize easily and are deposited in nearby water bodies. The effects of this over time congest local streams and rivers

with tons of sediment and contribute to both water quality impairments and roadway deterioration.

About Rural Roads Active Management Program (RRAMP)

The Rural Roads Active Management Program (RRAMP) has been created to provide county and municipal highway departments and private associations with techniques to improve travel corridor risk assessments, project prioritization strategies, best management practices selection, and funding assistance for critical sites.

The Lake Champlain Watershed of New York's Rural Roads Active Management Program aims to protect and enhance travel infrastructure and environmental protection through an all-inclusive inter-jurisdictional, regional effort.

RRAMP will engage and foster cooperation between numerous resource protection organizations and associations, the 55 municipalities, and five county highway departments throughout the watershed, to achieve program mission and goals.

Local RRAMP Partners

- County Soil and Water Conservation Districts (SWCD)
- Municipal Highway Departments
- County Highway Departments of Clinton, Essex, Franklin, Warren, Washington
- Lake Champlain/Lake George Regional Planning Board (LC-LG RPB)
- Lake Champlain Basin Program (LCBP)
- County Water Quality Coordinating Committees (WQCC)
- Adirondack Park Invasive Plant Program (APIPP)
- The Nature Conservancy – Adirondack Chapter
- Ausable River Association (AsRA)
- Boquet River Association (BRASS)
- Lake George Association (LGA)

RRAMP Program Mission

RRAMP's mission is to integrate a harmonious, climate

resilient, and sustainable network of secondary road corridors throughout the Lake Champlain Watershed of New York through cooperative implementation of conservation practices, critical site restoration, and strategic management.

RRAMP Program Goals

- Create a beneficial, uniform program for all municipalities in the Lake Champlain Watershed to utilize
- Provide **Best Management Practices**/resource protection guidance and maintenance manuals
- Assist municipalities with identifying opportunities to protect infrastructure and natural resources
- Provide financial assistance through a local grants program
- Obtain a long-term, continuous funding stream for program stability
- Improve and protect water quality and natural habitats impacted throughout the watershed

About Best Management Practices

Best Management Practices are general techniques or design practices that, when applied and adapted to fit site-specific conditions, will prevent or reduce pollution and maintain water quality. Since roads often have a major adverse impact on water quality, BMPs and guidance documents have been developed by various state and federal agencies. Many of those impacts are preventable with good designs, construction and management practices. Roads that are not well planned, properly designed, constructed, maintained or made with durable materials often have negative effects on water quality and the environment.

Purpose of this Manual

The purpose of this manual is to provide an introduction to the issues caused by erosion and sedimentation and to offer cost effective techniques and strategies that can be used to enhance and maintain rural roads while protecting and/or improving water quality. Town road managers and crews, private road maintenance and construction companies, loggers, select boards, lake, river and watershed associations and citizens, should utilize this document.

This manual provides many hands-on action techniques that can be used in a variety of situations. RRAMP is designed to help decision makers understand that using appropriate erosion and sediment control techniques is cost effective and often means wisely investing limited local revenues in a systematic way in order to realize long-term savings.

Problems Caused by Soil Erosion and Sedimentation

Soil erosion occurs when soil particles are carried away from a road bank, surface, ditch, or base by water, wind, ice, or gravity. Exposed soil, rapid water velocity, and the presence of fine sands and silts all increase the potential for soil erosion. Other non-point source pollutants such as oil and grease can also be washed from gravel roads as well. These sediments and pollutants are then carried into nearby waterbodies. If not properly managed, gravel roads, by nature of their topography and design, can contribute heavily to a significant water pollution problem.

Excess sediment is a major cause of water quality problems in both lakes and streams.

Large quantities of sediments and other pollutants can impact surface water ecosystems by:

- Smothering spawning and feeding habitats (fish eggs need a clean, sediment-free gravel-cobble-boulder stream bottom for incubation)
- Disturbing the reproductive cycle of many aquatic macroinvertebrates
- Increasing the frequency of flooding by filling river channels
- Altering the chemistry of the water
- Diminishing recreational uses

The checklist on the next page outlines cost-effective ways to manage drainage on a road system while protecting the quality of the Lake Champlain Basin surface waters.

Use this checklist to guide your road maintenance operations.

Rural Roads Active Management Checklist

- Crown roads to allow water to move quickly from the road surface into the ditches (approximately 1/2 to 3/4 inch per linear foot).
- Stabilize all exposed soil with seed and mulch, stone or erosion control blankets as soon as possible.
- Line ditches with slopes greater than or equal to 5% with stone.
- Line ditches with slopes less than 5% with vegetation (seed and mulch).
- Direct runoff into stabilized vegetated areas, where possible.
- Avoid concentrating runoff and keep runoff velocities as low as possible.
- Install culverts with a minimum diameter of 18 inches.
- Install stone aprons at culvert outlets where erosion is occurring.
- Install headers and/or wingwalls on culverts where erosion is occurring.
- Schedule and perform regular inspection and maintenance on culverts and ditches.
- Stabilize eroding banks with vegetation or stone.
- Disturb in a day only an area that can be stabilized that same day.

More Information

For further assistance, including information on erosion assessment, and planning grants, additional publications, and on-site assistance, please contact any of the CWICNY partners, listed in the Resource section.

Disclaimer: The information in this manual has been compiled from a number of reputable sources and reviewed by field specialists. It has not been verified for engineering integrity. This manual provides guidance on erosion control for rural roads, not definitive design specifications. Individual site conditions (i.e. soils, grades, proximity to water bodies, rates of flow, peak discharges, etc.) must be considered when projects are designed. The services of a professional engineer may be required in some instances.

Road Surfaces

Secondary roads carry local traffic between rural lands and villages, and provide connecting links between more heavily traveled routes. In New York's Lake Champlain Watershed, many of the local town roads have unpaved surfaces. The top layer of these roads is shaped, compacted, and smoothed so that surface water will move quickly from the road surface into established ditches

There are numerous distress indicators of surface deterioration and deformations. Fortunately there are a number of BMPs to address them.

SIGNS OF DISTRESS IN UNPAVED ROADS

Common Surface Deteriorations

Dust in the air results from the loss of fine, binder aggregates from road surfaces and leads to other types of road distress.

- Sprinkling water on the road surface is a very short-term solution.
- Applying calcium chloride is a common treatment that draws moisture from the air to improve fine aggregate cohesion; it is most effective if applied before roads become too dry and dusty and after any grading actions. Apply at a rate that keeps the surface moist but not so high as to cause water pollution or plant damage.
- Spray-on adhesives such as latex emulsions or resin in water are not recommended, as a potential exists for water quality impacts from the practice.

Ravelling is the loss of coarse aggregate from the road surface.

- Correct by grading or blading with the addition of a soil binder to improve surface composition.

Common Surface Deformations

Surface deformation problems can be reduced with proper road surface drainage. Common surface deformations include:

Potholes are caused by excessive moisture content, poor drainage, and poorly graded aggre-

Importance to Water Quality

The failure to direct water from the road surface to a drainage channel can result in the deterioration of the road surface, increased safety concerns (ice) and erosion problems. The immediate removal of runoff from the road surface will help in preventing erosion and the road's deterioration. This will lessen the frequency and cost of maintenance, and lengthen the life of the road surface. It may also decrease the volume of sediment carried into surface waters.

gates. Repair with spot grading (undercut potholes with grader blade—don't just fill them in!)

Rutting occurs when there is high moisture content in the road subsurface soil, resulting in longitudinal depressions left in the wheel paths.

- Grade, add suitable backfill material, and roll road surface.
- Adding stone is a temporary solution and is not recommended; draining the ruts and filling with correct roadbed material is preferred.
- For severe ruts, a layer of geotextile material may be required under at least six inches of crushed gravel.

Depressions are localized low areas of one or more inches below the surrounding road surfaces, caused by road settling, excessive moisture content, and improper drainage. Correct depressions by filling with well sorted aggregate, grading, and compacting.

Soft Spots are caused by lack of proper drainage from the road surface. Correct by replacing the area with a suitable material such as well-sorted stone or gravel.

Corrugations, also called washboards, are a series of ridges and depressions across the road surface caused by lack of surface cohesion and excessive vehicle speeds.

Correct by improving the cohesive qualities of the road surface: remix with a good percentage of fines, scarify the road surface while damp, regrade, re-crown, and roll the surface.

Blading is not recommended when considering repair of extreme corrugations.

General Road Surface Principles

- Preserve and maintain a proper road crown for good drainage (free water cannot be allowed to stand in ruts or potholes or it will soak into the surface.)
- Keep the road surface tight and impervious.
- Perform regular drainage maintenance and grading.

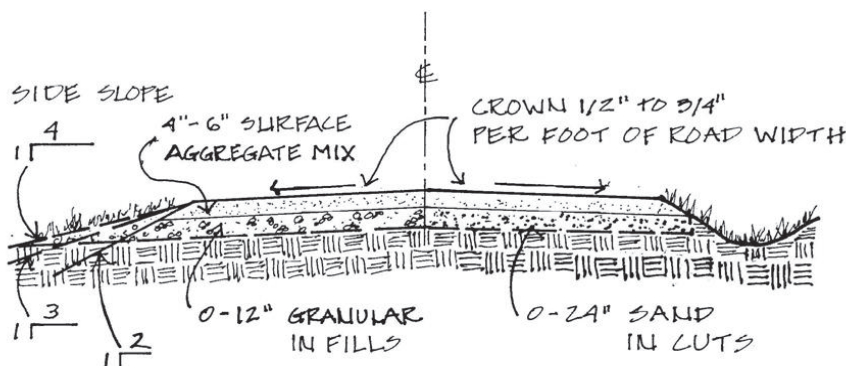

Road Crown & Profile

Surface Profile and Grading

- Grade roads in the spring as soon as the frost leaves the ground, or as soon as possible after rain while the surface materials are still moist but not wet.
- Remove any berm left on the road from winter sanding so that storm water can flow into the ditches and not erode the road surface.
- The amount of road surface disturbed should be limited to that which can be stabilized by the end of the workday.
- Do not grade if rain is in the forecast (*after* rain is best).
- Proper crowning and compacting of the road surface hastens the removal, which will reduce road surface erosion.
- Crown roads 1/2 to 3/4 inches for each foot of road width, measured from the center of the roadway to the outside edge to ensure good drainage.
- Slope roads with over-the-bank drainage

toward the ditched side of the road.

- Proper equipment for surface maintenance includes: grader (shaping and restoring), rake (smoothing before compaction), steel wheel roller (compaction), and slope board (slope confirmation).

Blading/dragging is a smoothing operation that pulls loose material from the sides of the road or spreads windrowed aggregate to fill surface irregularities and restore the road crown.

- Perform blading/dragging with the moldboard tilted forward with light downward pressure on the grader blade; adjust the angle of the moldboard to between 30 and 45 degrees; in most cases, tilt the front wheels slightly 10 to 15 degrees toward the direction the aggregate should be rolled.
- Avoid blading during dry periods to minimize the loss of fine aggregates.

Grading cuts through the road surface crust and is used when reshaping or when the correction of major surface defects is necessary.

- Perform grading operation with the moldboard tilted backward and with sufficient downward pressure on the blade to produce a cutting action; outer edge of the moldboard should be at the road surface's edge.
- Keep a minimum of one foot from the ditch line so that vegetation or rock stabilization is not disturbed.
- Grade roads in the spring or after rain. Avoid grading during dry periods to minimize material loss as dust.

Road Crown and Profile

- When possible, the entire width of the disturbed area of the roadway from grading should be compacted with a steel wheel roller by the end of the day.
- For a gravel road to shed water properly, it should have a tight, impervious surface.
- Construct the surface layer with well-graded soils and crushed rock.
- An aggregate mix recommended by the NYS DOT would be uniformly graded from coarse to fine. Approximate sizes for surface composition are: soil (<.074 mm), sand (.074-2.0 mm) and aggregate (>2.0 mm.).
- Add approximately 2 to 3 inches of new material to correct any faults.
- Scarifying the existing surface blends the soils and improves compaction.
- Add new material by running a truck down the center of the roadway and dumping; then blend with the existing material using a grader, followed by compaction using a steel wheel roller.
- Regravel road surface every 4 to 5 years with 2-3 inches of new gravel.

Shoulders

Road shoulders serve a number of useful functions by:

- Transferring water that has accumulated on the traveled portion of the road to the side slope and ditch;
- Serving as a safety zone and parking area for motorists; helping to support the road

surface; and separating the travel lane from the side slopes and ditches.

- Acting as collectors of winter sand and debris removed from the travel lanes.

Shaping the shoulders of the road must be done to allow water to drain. Unpaved shoulders are sloped at about twice the rate of the traveled lanes and often consist of less suitable material than the lanes. This happens over a period of time as winter sand and debris accumulate, or as ditches are maintained.

Shoulder Maintenance

For shoulder maintenance, blading is recommended.

- Adjust the blade so the inside edge of the shoulder is at the same elevation as the outside edge of the road surface. This will allow the water to drain and eliminate the possibility of secondary or false ditches.
- The shoulder should be bladed to recover loose aggregates and fines. At the same time, remove unwanted vegetation.
- The loose fines and aggregate should be spread on the road surface to help build the crown and stabilize the road surface.
- Shoulder drop minimum is 1 1/2 to 2 inches for a 2-foot shoulder and 3 to 4 inches for a 4-foot shoulder.

General Shoulder Maintenance

- Remove woody roadside vegetation (not grass) from the edge of the shoulder. The growth of thick woody vegetation can prevent water from flowing off the travel lanes, allowing it to pool at the edge of the shoulder.
- Mow and remove brush, weeds and other debris frequently before they grow large enough to create maintenance or safety issues.
- Remove winter sand and debris from the road shoulder to prevent stormwater flow from being disrupted. When grading the road, blade the edge of the shoulder to eliminate any build-up of sand and gravel.
- Ensure that the shoulder is flush with the road surface to prevent erosion at the road edge.

Waterbars

Waterbars are an inexpensive way to control and divert water from a road at selected intervals. These narrow bermed structures are constructed by forming a ridge or a ridge and channel diagonally across the sloping roadway. They may be shallow or deep depending on the anticipated runoff volumes. They can be used to divert water and prevent erosion on long, sloping roads. Waterbars work well for low volume roads and woods roads, but may not be suitable for the typical unpaved roadway where speeds are greater.

Best Management Practices for waterbars include:

- Construct low enough for traffic to pass over but high enough to direct runoff flow from the road.
- Install at about a 30-degree angle down slope.

- Ensure adequate drainage at the outflow, protected with stone, grass, sod, or other material that will reduce water velocity.
- Inspect regularly and rebuild as necessary.

Unpaved to Paved Considerations

If you finally decide to pave what has always been a gravel road take this into consideration: The surface of a gravel road that is to be paved should have far fewer “fines” than a road that is to remain gravel. The reason is that without a paved surface, the moisture in the road that is drawn up due to the wicking action of the fines is free to evaporate. Once the road is paved, the moisture will continue to be drawn up but its evaporation will be blocked. This can lead to frost heaving and other pavement problems. If you pave a gravel road that does not have the proper road base, the result is a waste of time and money.

Unpaved Road Surface Evaluation BMPS for Maintenance Work		
What you observe...	How bad is the problem?	Ways to fix it...
Improper drainage	Minor	<ul style="list-style-type: none"> ✓ Grade shoulders and ditches ✓ Clean ditches ✓ Install waterbars if appropriate
Improper drainage	Major	<ul style="list-style-type: none"> ✓ Clean and maintain ditches ✓ Reconstruct surface, base, and drainage ✓ Install waterbars if appropriate
Dust	Minor	<ul style="list-style-type: none"> ✓ Apply liquid/solid dust control
Dust	Major	<ul style="list-style-type: none"> ✓ Add minor gravel, regrade, compact
Improper Cross Section	Minor	<ul style="list-style-type: none"> ✓ Reshape (blading or dragging), ✓ Reshape with minor added material
Improper Cross Section	Major	<ul style="list-style-type: none"> ✓ Regrade ✓ Add appropriate volume of gravel, regrade, compact
Potholes	Minor	<ul style="list-style-type: none"> ✓ Spot regravelling

Unpaved Road Surface Evaluation BMPS for Maintenance Work		
What you observe...	How bad is the problem?	Ways to fix it...
Potholes	Major	<ul style="list-style-type: none"> ✓ Regrade ✓ Add appropriate volume of gravel, regrade, compact
Rutting	Minor	<ul style="list-style-type: none"> ✓ Reshape (blading or dragging) ✓ Reshape with minor added material
Rutting	Major	<ul style="list-style-type: none"> ✓ Regrade ✓ Add appropriate volume of gravel, regrade, compact
Loose Aggregates or Ravelling	Minor	<ul style="list-style-type: none"> ✓ Reshape (blading or dragging) ✓ Reshape with minor added material
Loose Aggregates or Ravelling	Major	<ul style="list-style-type: none"> ✓ Regrade ✓ Add appropriate volume of gravel, regrade, compact
Corrugations	Minor	<ul style="list-style-type: none"> ✓ Reshape (blading or dragging) ✓ Reshape with minor added material
Corrugations	Major	<ul style="list-style-type: none"> ✓ Regrade ✓ Add appropriate volume of gravel, regrade, compact
Soft Spots	Minor	<ul style="list-style-type: none"> ✓ Reshape (blading or dragging) ✓ Reshape with minor added material
Soft Spots	Major	<ul style="list-style-type: none"> ✓ Regrade ✓ Add appropriate volume of gravel, regrade, compact
Depressions	Minor	<ul style="list-style-type: none"> ✓ Reshape (blading or dragging) ✓ Reshape with minor added material
Depressions	Major	<ul style="list-style-type: none"> ✓ Regrade ✓ Add appropriate volume of gravel, regrade, compact

SURFACE MATERIALS

For an unpaved road to shed water properly, it should have a tight, impervious surface. This requirement calls for a higher percentage of “fines” than the base gravel under asphalt pavement. Unpaved surfaces with a small amount of fines do not have enough of this “binder” to hold the surface together when the weather is dry. As the surface falls apart, the loose material is thrown to the shoulders and ditches, and into the air as dust by vehicular traffic. Ruts, corrugations and potholes then appear.

Adding aggregates to the road base is usually accompanied by blading and dragging, although light applications of medium-sized and fine aggregates may be made occasionally to correct slippery conditions. When increasing the depth of the surface, filling depressions, restoring crown and profile, or correcting other problems that require coarse aggregates, an aggregate mix (with a maximum size of 1 inch) should be applied and spread with a grader.

Blading/Dragging: a smoothing operation that pulls loose material from the sides of the road or spreads windrowed aggregate to fill surface irregularities and restore the road crown.

- Perform blading/dragging with the moldboard tilted forward with light downward pressure on the grader blade; adjust the angle of the moldboard to between 30 and 45 degrees; in most cases, tilt the front wheels slightly 10 to 15 degrees toward the direction the aggregate should roll.
- Avoid blading during dry periods to minimize the loss of fine aggregates.

Grading: cuts through the road surface crust; used when reshaping or when the correction of a major surface defect is necessary.

- Perform grading operation with the moldboard tilted backward and with sufficient downward pressure on the blade to produce a cutting action; the outer edge of the moldboard should be at the road surface’s edge.
- Keep a minimum of one foot from the ditch line so that any vegetation or rock stabilization is not disturbed.

- Grade roads in the spring or after rain. Avoid grading during dry periods to minimize material loss as dust.
- When possible, the entire width of the roadway disturbed by grading should be compacted with a steel wheel roller by the end of the day.
- For a gravel road to shed water properly, it should have a tight, impervious surface.
- Construct the surface layer with well-graded soils and crushed rock.
- An aggregate mix recommended by the NYS DOT would be uniformly graded from coarse to fine. Approximate sizes for surface composition are: soil (<.074 mm), sand (.074-2.0 mm) and aggregate (>2.0 mm.).
- Add approximately 2 to 3 inches of new material to correct any faults.
- Scarifying the existing surface blends the soils and improves compaction.
- Add new material by running a truck down the center of the roadway and dumping; then blend with the existing material using a grader, followed by compaction using a steel wheel roller.
- Regravel road surface every 4 to 5 years with 2-3 inches of new gravel.

Disposal of Excess Materials

Improper disposal of excess material can increase the amount of sediment that enters streams and damages sensitive areas, such as wetlands.

- Excess material should not be disposed of in wetlands, drainage ditches, swales, stream banks, areas within 50 feet of a waterway, slopes that are more than 2 horizontal: 1 vertical or other locations that may be subject to erosion.
- Be sure that the area downhill of the disposal area has an adequate vegetated filter strip to trap sediments.
- Seed or vegetate any fill areas as soon as possible.
- Plan potential disposal areas ahead of time, giving the opportunity to utilize excess materials if possible.

Erosion and Sediment Control Overview

To correctly plan for, and use, Best Management Practices for rural roads, it's important to have a basic understanding of erosion and sedimentation – two very distinct processes -- how they happen, and the types of damage they cause. There are also two distinct factors of erosion and sedimentation control Best Management Practices: those that are for **permanent erosion control** at rural road sites, and those that are **temporary erosion control needed** at a work site during a work project.

This chapter explains details of the erosion and sedimentation processes. In the following chapters of this Manual you will find details of the various erosion control methods with helpful illustrations.

Erosion

Erosion is the detachment and movement of soil particles by the action of water, ice, gravity, or wind. Natural erosion always occurs, but at a rate that is slow enough that the environment can adjust. When humans begin to manipulate the landscape, we accelerate the process by exposing soil to the forces of water and wind.

Erosion and runoff can be serious issues along roadsides, both during and after road projects. In addition to losing valuable soil resources, erosion results in an unhealthy environment for establishing and maintaining vegetation, pollutes waterways with sediment, and results in costly maintenance activities to repair damage. Damage at a site may include rilled and gullied slopes, washed-out ditches, damage to pavement and drainage structures, clogged pipes, and flooding. Damage to water bodies occurs when they become filled with sediment, making them susceptible to flooding and stream bank erosion.

Sedimentation

Sedimentation is the deposition of soil particles that are detached and transported by the erosion process. Sedimentation occurs when the velocity of the wind or water becomes insufficient to keep the soil particles in suspension. Particles can be transported great distances and deposited in

Importance to Water Quality

Erosion occurs when individual soil particles are carried away from the road surface, ditch, or road base by water, wind, ice, or gravity. These soil particles are often transported by runoff to streams, ponds, and lakes where they can alter the water chemistry, affecting the quality of water and fish habitat. Sediments can impact surface water ecosystems by adding excess nutrients that deplete oxygen supplies, smothering spawning and feeding habitat of fish, and contaminating drinking water supplies. By using the BMPs outlined in this manual and following the accepted guidelines, erosion from roadways and road related projects can be controlled, ensuring the quality of the adjacent waters and wetlands.

environmentally sensitive areas such as rivers, lakes, and wetlands. Sedimentation can severely alter water quality, damage an aquatic ecosystem, and destroy a wetland.

Types of Erosion and the Erosion Process

To prevent erosion or to control its effects, it is important to understand the types of erosion involved. Four are water related: rain drop impact, sheet flow, rill erosion, and gully erosion. Wind is also a factor in erosion. Because the problems caused by erosion increase in severity, it is vital to control erosion in its initial stages. The type of runoff determines the types of erosion.

Types of Erosion

From *Minnesota Erosion & Sediment Control Design Guidance*,
Office of Environmental Services, Minnesota Department of Transportation. 1/1/2010

Type of Erosion	Description	Techniques for Minimization
Raindrop splash	The impact of the raindrop dislodges soil, causing bare soil to splash into the air. The effect of the splash also increases compaction and destroys open soil structure.	✓ Stabilize the soil with mulch or permanent cover to prevent raindrop impact.
Sheet erosion	The transporting of soil loosened by raindrop splash and removal of soil from sloping land in thin layers. It is a function of soil type, depth, and flow velocity.	✓ Divert overland flow away from the slope or break up long slopes with terraces.
Rill erosion	When sheet flow becomes concentrated in small, defined channels. Most rainfall erosion occurs this way.	✓ Stabilizing slopes and divert flow. Repair damage immediately with disking or tilling.
Gully erosion	Occurs when sheet flow becomes concentrated in large defined channels. This occurs in unrepaired rill erosion areas.	✓ Same as rill erosion, but gully erosion requires extensive repair.
Channel erosion	Channel erosion occurs at stream banks and causes sediment scar along the channel bottom.	✓ Proper design through stream geomorphology techniques.
Wind erosion	Detachment and transport of soils by wind.	✓ Utilize windbreaks, seed & mulch, and/or synthetic covers on stockpiles.

Evidence of Erosion on Roadways

Road surfaces may not necessarily be impacted by erosion. They are significantly impacted by improper construction and from groundwater. There are a number of ways distress may be evident on a road surface.

Signs of Surface Deterioration:

- Dust
- Slipperiness
- Soil Deposition on the road
- Raveling

Signs of Surface Deformation:

- Corrugation/Washboards
- Depressions
- Rutting
- Potholes
- Soft spots

Methods of Erosion Control

There are four distinct methods that can be used to control erosion on a worksite. Choosing the method that will work best for a particular situation is critical

to the success of the work. There are four major methods that can be used to control erosion:

- Non-structural and management
- Structural
- Bioengineering
- Biotechnical

Details of Erosion Processes

Raindrop Erosion occurs when raindrops hit bare soil. The force of this impact dislodges soil particles and splashes them into the air. How much this occurs depends on the intensity of the velocity and size of the raindrops and how much silt, clay and sand is in the soil. The harder the rain and the finer the soil texture, the more raindrop erosion will occur. A large raindrop will fall at a rate of 30 feet/second and may be up to 250 times larger than a silt particle. Sand, on the other-hand, may be the same or up to twice the size of that raindrop so it has a better capacity for absorbing raindrop impact and staying in place. As soon as water begins to collect on the ground surface, runoff begins. In addition to water, all soil particles dislodged by the raindrops are suspended in the water. If the land has even the slightest slope, the fine-textured soils will stay in suspension and begin to move with the runoff. At this point sheet erosion, the second type of erosion occurs.

Sheet Erosion occurs on unprotected soil when sheetflow runoff begins. Sheet erosion usually moves the *greatest amount* of soil from an unprotected job site. The depth of water during sheet runoff is typically only a fraction of an inch, but that can be six to six thousand times deeper than the soil particles it is flowing over – and depth and velocity is power. This relative tidal wave of water easily picks up soil particles and carries them away. How fast and far this sheet of water flows depends on the surface cover and roughness, and the slope of the land. For instance, the loss of just 1/8 of an inch of soil off one acre of land will fill a 10-wheel dump truck (15 cu.yds. or 25 tons). On steep, unvegetated highway back slopes sheet erosion may only occur for twenty feet before it develops into Rill Erosion, the next form of erosion.

Rill Erosion occurs when sheet erosion gains enough power (velocity and depth) to concentrate and cut very small channels into the soil. As more water flows into these small channels, the water depth and power increases and they cut deeper into the soil. These small channels are called rills. They are no more than an inch wide and one to two inches deep. Keep in mind that between these rills, raindrop and sheet erosion is still occurring. This water will also flow down the slope parallel to the rills, combine with the rills and form gully erosion, the most destructive form of erosion.

Gully Erosion occurs when water is concentrated and flows with enough power (velocity and depth) to cut into the soil to a depth of over one foot. It will occur as a result of rills coming together on an unprotected slope. On road projects, gullies form near the base of long slopes, in the bottom of an unprotected ditch, or as water flows off of a road surface, parking lot or other flat grade onto a steep unprotected slope. Interestingly, gullies form from the bottom of the slope and progress uphill. When the flowing water reaches a critical level, a small waterfall forms and the power of the water falling over the edge (increased velocity) erodes the soil at that point and this erosion proceeds upstream. This small waterfall that moves upstream is called a “head cut” and leaves steep banks downstream. The steep banks will begin to collapse under their own weight, that soil will also wash away, and the gully widens further. Gullies and head cuts will form anywhere the power of water is strong enough to begin to scour the soil. When left untreated, head cutting will continue a repetitive process of migrating up slope, removing unstable soils, increasing gully depth, resulting in slope and road shoulder failures. At the lower reaches, the gully will continue to cut downward and widen out to the point that the slope may actually flatten out, slowing the velocity and decreasing energy, allowing sediments to deposit in the gully.

Wind Erosion occurs when the wind dislodges, picks up, and transports the soils. As with water, the texture of the soil moved depends on the power of the eroding force. Wind can cause dust clouds or sand storms. It occurs when the soil is dry, loses or has no cohesion, and is unprotected from the power of the wind. Dust can be a major form of non-point source pollution.

Temporary Erosion and Sedimentation Control

Temporary erosion control Best Management Practices are devices and methods needed to control erosion. Erosion control is protecting and preventing the exposed soil from eroding, with correct shaping, temporary seed, mulch, blanket, and other needed devices. These other devices may include sandbag barriers; temporary drains for fill slopes or temporary flumes to safely carry water down a slope. Determining the best practices and incorporating them into a rural road project requires proper planning, and knowledge and the experience to develop and apply erosion and sedimentation controls properly.

The Erosion and Sediment Control Plan (ESCP)

When applicable, state and federal regulations require assurance that the proper BMPs will be installed in the right sequence and maintained for their intended use: a written plan is required. The purpose of the plan is for the contractor to focus on site considerations, integrating BMPs into the construction project. It is essential that the person formulating the ESCP understand the construction process and the basic principles of ESCP and how the BMPs function. The complexity of the plan will depend on the size and unique situations involved with the project, including the amount of exposed soil, the proximity of the project to a water body, and the sensitivity of the water body. If the project is completed in a single day, an abbreviated plan may be necessary to simply seed and mulch all disturbed areas and inspect and maintain the site until the grass germinates. If the project is large, complex, and extends over multiple construction seasons then sequencing of construction and BMP installation with the phases of the project may be complicated, and inspection and maintenance will require more time and effort. Plan revisions and updates may be necessary depending on weather conditions or changes in project scope.

PRINCIPLES OF A SOIL EROSION AND WATER POLLUTION CONTROL PLAN (SEWPCP)

When developing a SEWPCP for a construction project, the following six principles will help guide

you in developing and implementing the plan. All six general principles apply to all earthmoving construction sites, but all sub-categories may not.

Know the Watershed

Know where the project is located in the watershed and how much of the watershed is above the site. Before choosing BMPs, look for signs of concentrated flow (either storm water or spring runoff). If they exist, look at the watershed above the back slopes, private driveways that concentrate flow to road ditches, and length of ditches and off site watersheds that flow to them. Are there indications of seeps and continuous flow?

Know the soils and materials that you are working with. Are they highly erodible? Do they drain well? Are you dealing with steep slopes on which it may be difficult to establish vegetation?

Land use, location, and time of year. Look at the land use cover. In general, wooded areas will produce runoff slowly but for a longer time. Urban areas will quickly produce larger amounts of runoff for a given rainfall. Anticipating flow rates is critical to good water management. Consider how much sun the project site gets. If you are on the north side of a slope, soils may not dry out and grass grows slowly. If you are in an open area exposed to the sun and wind, the soil may dry out too quickly, grass may need to be watered, and dust control will be a concern. The time of year has similar effects on soil moisture and establishment of vegetation. Also consider that summer thunderstorms are quick-hitting and intense while fall and spring rains tend to be less intense but last longer

Know where the water goes when it leaves the site and what the water resources are. If not identified in the plans, assume that any stream, lake, pond, or wetland should be avoided and protected before any earthmoving occurs. When in doubt, ask. Always walk or drive the site, use a map if necessary, and identify where the water goes and how far away your project is from the water resources. More importantly, how does it get there? If it is sheet flow through a buffer there is an opportunity for treatment; if it is concentrated flow, there is not.

Construction Timing and Phasing

Minimize clearing. Keep disturbed areas at a

minimum! Only open up what you can manage. The smaller the bare soil area exposed to rainfall and runoff, erosion will be kept to a minimum. Avoid clearing steep and long slopes. Each site is unique. Give special consideration to slopes greater than 3:1 and longer than 50 feet.

Disturb from the bottom up. On projects where the excavation is used to build, plan and stage the work such that the bare soil area is kept to a minimum. For all concentrated flow channels (ditches), stabilize the outlet first and build from the bottom up. Only excavate what can be stabilized or protected by the end of the workday. All cross culvert outlets should be armored before the end of the workday.

Winter stabilization. Time of year is critical for stabilization. Spring thaws and rain events cause the most erosion. Surface soils are usually saturated and have little strength, and vegetation is laid down or dead providing less protection from rainfall and runoff. If construction will extend into late fall or later, consider the need for appropriate erosion and sedimentation controls to be in place and functioning as the snow melts the following year.

In-water work. Fishery agencies (USFWS, NYS DEC) require that work within a stream, or other water body occurs only during certain months of the year (typically mid July through September). Schedule operations within those months accordingly.

Control the Water

Divert. Disperse. Detain. The key to Erosion and Soil Control is to keep the depth (volume) and velocity of water as low as possible. Whenever possible:

Divert clean water away from the exposed soil. Use temporary ditches, hillside diversions, and downspouts to carry water from the uphill watershed away from exposed soil. This may be around or through the site. Be sure that constructed channels are stable before they receive runoff. Because it takes time for vegetative channels to stabilize, this will usually require using riprap or plastic sheeting to divert the water.

Disperse the flows. Where practicable keep runoff water in sheet flow and treat smaller areas with sedimentation control BMPs such as Erosion Control Mix Seeding, Berms, and Silt Fence.

Detain dirty water. Whether in sheet flow or concentrated flow, detaining the water – slowing it down – removes sediment. Use appropriate sedimentation control BMPs.

Soil Stabilization

Temporary stabilization. Mulch is the most effective BMP! Stop erosion before it starts! Most sites should have temporary mulch applied at the end of each workday through mechanical or hand methods. Mulch will protect the soil from raindrop impact and promote infiltration of runoff into the soil. This will decrease the volume of water that runs off the site. Mulch will also slow down sheet runoff. Refer to the mulch BMPs for various types of covers. Remember slope and slope length are critical to when sheet erosion turns into rill erosion, and then gully erosion. Consider using grading techniques in combination with mulches to limit slope length.

Permanent stabilization. Place final treatments as soon as possible after final grading. Install permanent erosion control BMPs, such as riprap downspouts, or stone ditch protection, as part of the slope or ditch construction, and vegetative windbreaks.

Keep Sediment On-Site

Last line of defense/first Best Management Practice. Sedimentation control is the last line of defense in keeping sediment out of water resources, but it should be the first BMP installed as insurance against not having 100% erosion control. It provides a final treatment of all runoff.

Management

Assign responsibility to crews. As with any job that needs to be done, there must be someone in charge on site. For erosion and sedimentation control that person needs to be a person must ensure that the proper practices are followed and practices maintained.

Inspect and maintain. Erosion and sedimentation control maintenance requires inspection and, if needed, correction at least once a week and before, during, and after storm events. Erosion and sedimentation control is a daily activity on any earthmoving construction project, therefore erosion and sediment controls should be

considered as critical as maintaining equipment to avoid unexpected problems.

Follow-up: remove temporary sediment control barriers. Temporary measures such as check dams, sediment barriers, temporary slope drains, etc. must be removed when disturbed areas are permanently stabilized. If left on-site, temporary measures may actually cause erosion and be an eyesore for years. Erosion control berms may not have to be removed. In most circumstances they can be spread out, seeded and left to decompose. However silt fence and other temporary barriers must be removed from the site. Areas disturbed during the removal of these devices must be properly stabilized.

Spill Prevention

Although spill prevention is not specifically covered in this manual it is a water quality issue that must be addressed during construction. Leaks from hydraulic hoses or fuel spills and leaks can have great impacts on surface and ground water resources. To minimize the environmental impacts associated with unplanned releases, it is important to ensure that “good housekeeping” practices are followed and that prompt actions are taken to respond to spills or leaks. Unto that end, the contractor shall use proper fuel filling procedures, maintain equipment to prevent leaks, have “spill kits” on the jobsite to clean up spills if they occur, and develop a project specific plan for responding to releases. Most importantly, crews should know who to call if there is a spill, and the proper procedures for reporting and cleanup.

PROJECT DEVELOPMENT PLAN

Erosion Assessment and Capital Budget Planning

It is costly and time consuming to repair damage caused by excess water or poor drainage, especially when damage is caused over and over in the same location. The environmental and recreational impacts of silt and gravel settling in streams, rivers and lakes are high. Most road managers appreciate the need for adequate funds to fix a problem correctly the first time, yet may be having difficulty securing the funds.

Towns with an up-to-date inventory of road conditions with respect to erosion and a capital budget plan for fixing problems can tackle these issues in a systematic and justifiable manner. The basic premises are:

- People make the best decisions when they have an extensive knowledge about the specific site.
- Fixing a problem site once and for all, although it may be more costly up front, actually pays for itself in a short period of time by reducing recurring “Band-Aid” maintenance.

There are many resources to help develop inventories and capital budgets. Contact your local SWCD for more information.

Erosion Control Overview		
Practice	General Effectiveness	Application Areas
Shaping and Grading	Good to excellent	<ul style="list-style-type: none"> ✓ Slopes and ditches as construction progresses.
Mulch/Seed	Excellent	<ul style="list-style-type: none"> ✓ Bare soil. ✓ All exposed slopes that will not be worked on within the time frame allowed. ✓ Idle areas, including stock piles.
Erosion Control Blanket	Excellent	<ul style="list-style-type: none"> ✓ Slopes steeper than 1:3. ✓ Erosive ditch bottoms (v-shaped). ✓ Ditch bottoms that outlet to a surface water. ✓ Highly erodible areas such as bridge slopes, pipe outlets, high volume exit points.
Temporary Drain on Slope	Good	<ul style="list-style-type: none"> ✓ To convey drainage down cut or fill slopes.
Bituminous Flume	Good	<ul style="list-style-type: none"> ✓ To convey concentrated drainage on temporary fills, temporary bypasses, or temporary ditches. ✓ Use on projects with erosive potential longer than one season.
Rock Flume	Good	<ul style="list-style-type: none"> ✓ Use on projects with erosive potential longer than one season.
Sod Flume	Good	<ul style="list-style-type: none"> ✓ Use on projects with erosive potential longer than one season.
Diversion Mound	Good	<ul style="list-style-type: none"> ✓ For use at the top of backslope or fill slope. ✓ Can be used to divert runoff.
Wind Break/Living Snow Fence	Good to excellent	<ul style="list-style-type: none"> ✓ Controls soil erosion, minimizing sedimentation.

Ditches (Concentrated Flow Channels)

Ditches are constructed to convey water from roads to an adequate outlet without causing erosion or sedimentation. If properly constructed, they are ideal for collecting and dispersing water in a controlled manor. A stable ditch needs to be shaped and lined using the appropriate vegetative and structural material. Ditches can remove water quickly and reduce seepage into the road subgrade however, to be effective, ditches need to be properly maintained. They need to be placed at specific sites to protect down gradient structures such as bridges and culverts, or to utilize specific erosion control or stormwater discharge facilities.

Ditching General Principles

- ✓ Ensure that the ditch is properly lined to prevent erosion.
- ✓ Perform regular maintenance to keep ditch clear and stable, and to maintain capacity of channel.
- ✓ Always clean ditches from the uphill slope.
- ✓ Have erosion control material ready before starting job.
- ✓ Install erosion control protection prior to activity, and stabilize site upon completion.
- ✓ When in doubt GET HELP from, SWCD, and other regional resources.

Ditch Assessment Checklist

(Adapted from Massachusetts Dirt Road BMP)

- Is the ditch deep enough to drain subgrade and/or cut off subsurface water?
- Is the ditch wide enough?
- Is there adequate slope to the ditch line to prevent ponding?
- Is the ditch free of obstructions?
- Has erosion started at spot locations in the ditch?
- Is the ditch lining (stone or vegetation) holding up?
- Could velocity dissipaters be used to slow down the water?
- Does the ditch have a stable outlet?

Importance to Water Quality

Ditches prevent water from reaching a road's sub-base by disposing of surface runoff from the road surface and adjacent areas. Roadside ditches allow the road base to drain and prevent saturation and loss of support. Properly constructed ditches will quickly remove run off and reduce seepage. A properly constructed ditch must be shaped and lined, using the most appropriate structural material. A ditch's alignment should be kept as simple as possible, with smooth curves and transitions to minimize any erosion potential.

Ditch Profiling and Grading

Proper ditch profile and grading techniques will remove water efficiently, decrease erosion, and increase the length of time between cleaning and regrading, thus reducing maintenance costs.

- Locate ditches on the up slope side of the road to prevent water from flowing onto the road from uphill.
- Design and grade ditch and bank side slopes at a maximum 2 horizontal: 1 vertical ratio.
- Excavate a ditch deep enough to drain the road base and handle expected runoff - 1.5 to 2 feet deep, depending on the topography.
- The ditch should be slightly rounded (parabolic shape preferred) or trapezoidal and at least 2 feet wide to help slow and disperse water.
- Size ditches so they are large enough to handle runoff from the drainage area.
- The preferred equipment for creating ditches is a rubber-tire excavator with an articulated bucket.
- Line ditches that have a less than 5% slope with grass in order to filter sediments.
- Use mulch or erosion control blankets to hold seed in place and allow it to become established.

- Line ditches that have a greater than 5% slope with stone (i.e. riprap).
- Line ditches as soon as possible to prevent erosion and to maintain the ditch profile.
- Ditches should convey water away from the road and prevent standing water, which can weaken the road.
- Outlet ditches into vegetated, stable areas, where possible.
- Vegetate ditches with appropriate seed and erosion control measures to allow for seasonal germination and to provide adequate protection for winter.
- Prevent water from standing in a ditch – standing water weakens roads.

Ditch Linings		
Channel Slope	Lining	Thickness
0-5%	Grass	
5-10 %	R#3 (2-3 inch) diameter rock	7.5"
>10	R#4 (3-12 inch) diameter rock	12"

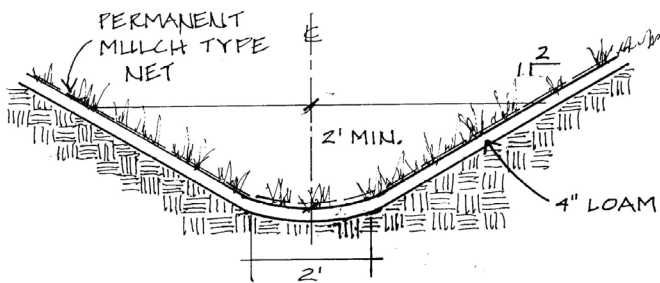

Grass Lined Ditch

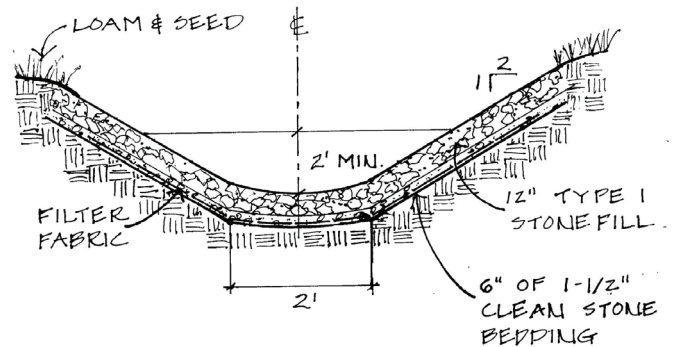

Stone Lined Ditch

Ditch Types

Diversion Ditches & Berms Diversion ditches and berms (earth dikes) are used to re-direct stormwater runoff. They may be located above steep slopes, across long slopes, or below steep grades. Their purpose is to intercept surface runoff from the slope and convey it away from the road. This reduces the volume of water that has to be carried to the roadside drainage system and protects the slope from excessive runoff and greater erosion problems.

- Use diversion ditches & berms to intercept, contain, and direct runoff.
- Locate at the top of a slope to prevent gullies, rills on slopes, or across the slope to break up the slope or redirect water flow.

Ditches and berms may be used in combination where runoff is significant and/or hard to control.

- Locate diversion ditches and berms where they will empty into stable retention areas to collect sediment.
- Design and line diversion ditches the same as other ditches.

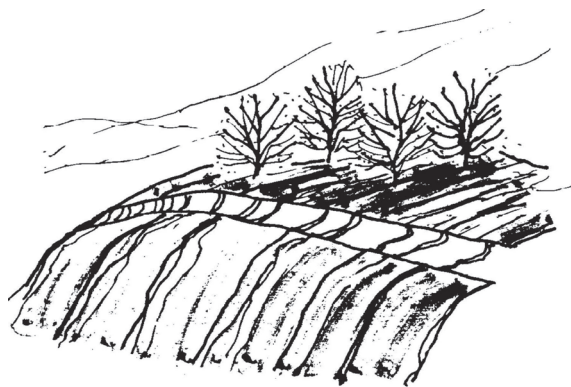

Diversion Ditch

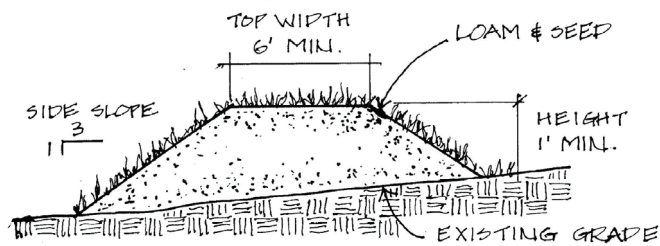

Diversion Berm

Turn-outs/Tail Ditches Turnouts are extensions of ditches that direct water to stable filtering areas. There must be adequate outlet protection at the end of the turnout area, either a structural (rock) or vegetative area. (See the Section on *OUTLET PROTECTION* for details on the construction of proper outlet areas.)

- Follow culvert requirements for spacing. (See the Section on *CULVERTS*.)
- Use only in areas where the water will flow positively in a filtering area, preferably away from the road and adjacent surface waters.
- Line ditches that have a channel slope less than 5% with grass, and line those that have a 5% or greater channel slope with geo-fabric or aggregate filter underlain riprap or other material.
- Line and/or seed ditches as soon as possible to prevent erosion and to maintain the ditch profile. Whenever possible, excavate a ditch only as far the selected stabilization technique can be installed prior to a storm event or the end of the work day. Temporary lining may be necessary in the event of unanticipated rainfall.

Velocity Controls and Energy Dissipaters

Where temporary or permanent channels are not yet stabilized, velocity controls must be used. Velocity controls and energy dissipaters, also called "check dams", are used to slow the water flowing through ditches and swales. A decrease in water velocity reduces erosion potential and allows sediment to settle out behind the check dam. They may be constructed from stone, coir logs, or fabric socks. They are very effective at keeping brush, trash, sediment and other debris from reaching and plugging culverts.

Locate in ditch channel or near culvert outlet.

- Used to slow the water flowing through ditches and culverts.
- Reduces erosion by preventing scouring of ditches and culvert beds and outlets.
- Collect sediment and help groundwater recharge.
- Types of velocity controls and energy dissipaters include check dams made from stone or logs, geotextile/urethane foam/mulch filled dykes, and brush.
- The dams should be spaced so that the toe of the upstream dam is equivalent to the crest of the downstream dam.

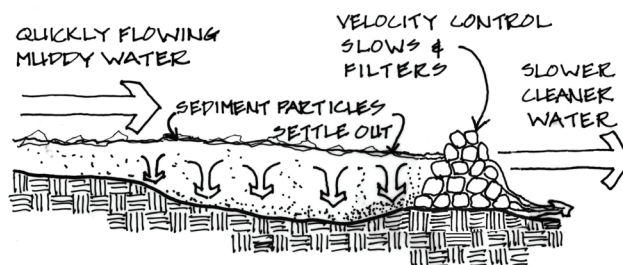

Velocity Control

Stone Check Dams: constructed of stone large enough to handle the expected velocity of water.

- More permanent than most other types of controls.
- Can be easily expanded if necessary.
- The smaller the stone size, the more sediment that is removed.
- Easy installation.
- Must be lined with fabric to prevent scouring.

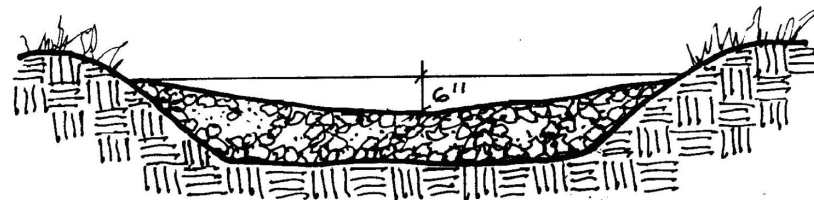
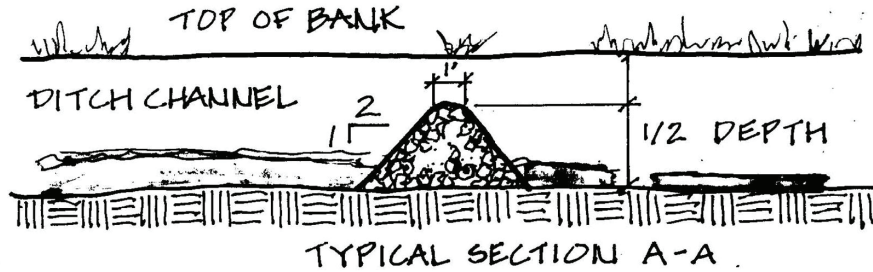
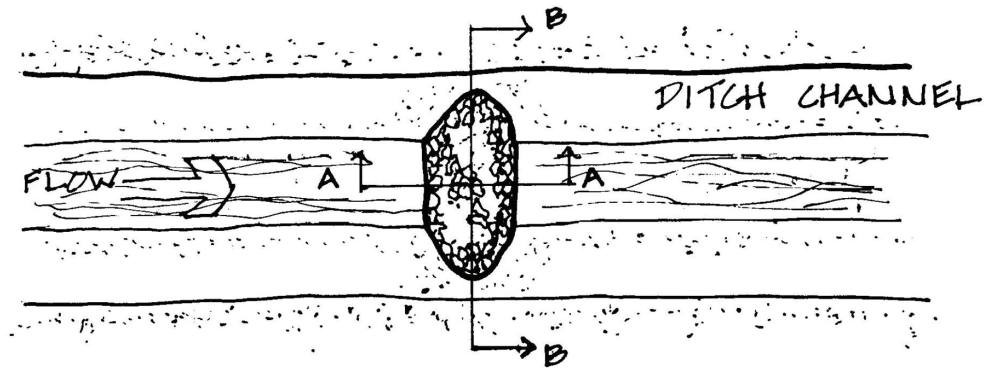

Stone Check Dams

Geotextile/urethane foam/mulch filled dykes

- Light-weight and reusable.
- Flexibility of the materials in foam/mulch filled dikes allows them to conform to all channel configurations.
- Easily fastened to soil with staples or rock and pavement with adhesives.

Log and Brush Check Dams: Constructed brush intermeshed with logs staked into the ground.

- Materials for these dams can be gathered on site making them convenient and inexpensive.
- Good emergency control.
- Installation technique is critical to performance.
- Difficult to remove and repair.

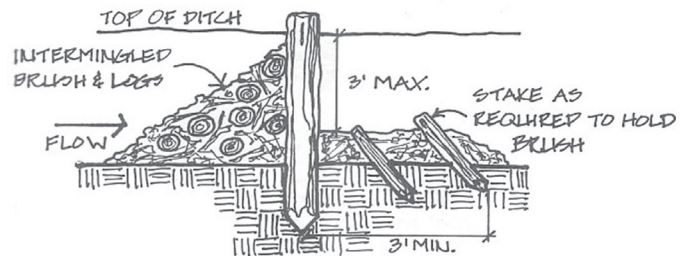
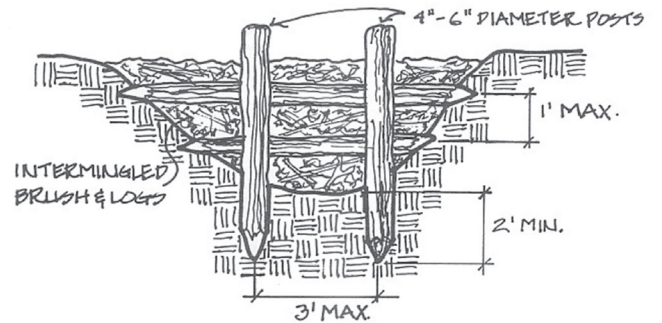

Log & Brush Check Dams

Cleaning & Maintenance

Ditch Routine Inspection, Maintenance, and Cleaning Checklists

All Year

- ✓ Check dams need to be maintained when their sediment trapping volume is reduced to 60%.

Spring and Summer Activities

Check ditches after major storms to identify obstructions, erosion, or collapsed banks.

- ✓ Regrade ditches only when absolutely necessary and line with vegetation or stone as soon as possible.
- ✓ Clean and remove fallen brush, leaves, trash, sediment, and other debris from the ditch to prevent overflows and out washes.
- ✓ Reshape the ditch to improve flow capacity.
- ✓ Re-establish and/or improve the cover type.
- ✓ Earth – Seed, mulch, and apply erosion control matting to prevent erosion.
- ✓ Grass – Reseed, mulch and apply erosion control matting. Mow and trim out brush.

- ✓ Stone – Add stone to slopes and low spots, if necessary. Place or form stones to fit ditch shape. Patch broken or washed out areas to prevent further damage and erosion.

Additional Fall and Winter Activities

- ✓ Keep critical sections free from snow and ice to prevent spring flooding.
- ✓ The main concern is to limit disturbance to the ditches during times of high erosion potential.
- ✓ Have a post-storm assessment plan for checking for damage and determining maintenance needs.
- ✓ Check all ditches, including tail-ditches and turnouts, after major storm events, looking for obstructions, erosion, or bank collapse that a storm may have caused.
- ✓ Clean out ditches, when they become clogged with sediments or debris, to prevent ponding, bank overflows, and road washouts.
- ✓ Re-grade ditches only when absolutely necessary and re-seed or stone as soon as possible. Re-grading of ditches should be limited to late spring or summer, after spring rains have diminished and drier weather has set in, and when vegetation can be re-established.



Matrix of BMPs for Ditch Maintenance

You observe...	Degree of the problem	To fix it:
Erosion in ditch	Minor	<ul style="list-style-type: none"> ✓ Perform regular maintenance ✓ Line ditch appropriately ✓ Install velocity controls*
Erosion in ditch	Major	<ul style="list-style-type: none"> ✓ Perform regular maintenance ✓ Regrade ditch ✓ Line ditch appropriately ✓ Install velocity controls*
Ditch can't handle volume	Minor	<ul style="list-style-type: none"> ✓ Install ditch turnouts ✓ Increase ditch width, depth
Ditch can't handle volume	Major	<ul style="list-style-type: none"> ✓ Install ditch turnouts ✓ Construct diversion ditches/berms ✓ Increase width/depth

*When making decisions about the use of velocity controls, keep in mind that the ditch size will be determined by water velocity and volume. The use of velocity controls in anything but a small shallow ditch should generally be referred to an engineer to ensure appropriate design.

Ditch Lining Materials

From Cornell Local Roads

Ditch Lining Materials		
	Erodibility	Water Retardance
High  Low	Earth	Concrete
	Earth bottom/ grasses sides	Fabric
	Grassed (mowed)	Earth
	Weed & Grass (unmowed)	Stone bottom & sides
	Stone bottom/ grasses sides	Earth bottom / grassed sides
	Fabric	Stone bottom/ grassed sides
	Stone bottom & sides	Grass
	Concrete	Weeds & Grass (unmowed)
		Low  High

Important Considerations for Ditch Lining Materials

Soil

- Severe erosion problems can occur.

Exposed (bare soil) Bottom

- Condition of ditch after cleaning. Needs to be properly seeded to reduce invasive weeds from growing, causing a stabilization retardance problem.

Fabric

- Only certain fabrics (geotextiles) can be used in this application. Contact the SWCD for advice.

Concrete

- Concrete and asphalt ditches are prone to heaving and undermining. They require vigilant maintenance as well as quality construction.

Culverts

A culvert is a closed conduit used to convey water from one location to another, usually from one side of a road to the other. A very wide or long culvert may be considered a bridge. The installation of a culvert is usually a simple operation, yet it is a process that is notorious for being done incorrectly or haphazardly. Proper installation, sizing, and routine maintenance of culverts are necessary to ensure human safety, integrity of the roadway, protection of surrounding property, aquatic passage, improved water quality and decreases in traffic delays.

General Culvert Principles

- ✓ Inspect on a regular basis.
- ✓ Protect inlets and outlets by marking their location, stabilizing entry and exit zones and maintaining ditch lining to prevent erosion.
- ✓ Practice preventative maintenance to avoid clogging, washouts, and settlement.

Culvert Considerations

Culvert installation should occur during periods of low stream flow (Note: it is best to divert the stream while culvert is being installed to avoid sedimentation of the stream) or during dry periods. Any time a new culvert is being planned for installation or replacement in a stream, several permits and design considerations may be necessary from NYSDEC, US Army Corps of Engineers and Adirondack Park Agency. Contact your SWCD for guidance.

In-Stream Culvert Considerations

- Adequate Design and Sizing is Critical!
- Disturb the natural channel system and adjacent land as little as possible.
- Align culverts and set the grade to match the existing stream channel as close as possible.
- Incorporate aquatic organism passage into the design. Contact SWCD for assistance.

Stream Geomorphic assessment data and technical assistance (information about changes and adjustments in a stream and what changes may be

Importance to Water Quality

Properly placed culverts will help alleviate ditch maintenance problems by outleting water in a timely manner.

Correctly sizing and maintaining culverts will help in preventing flooding problems that can lead to erosion and repairs. Placing culverts and other outlets based upon road slope will control the volume and velocity of discharges and reduce the amount of sediment entering surface waters. Culverts preserve the road base by draining water from ditches along the road, keeping the sub-base dry.

anticipated in the future) for streams throughout the NY watershed is available from your local SWCD.

Non-Stream Culvert Considerations

- Outlet ditch culverts to a vegetated or stabilized area - never directly into a stream.
- A 0.5% slope is the minimum to allow for positive drainage flow and should be used in all culvert designs, except equalizers.
- Set grade to where the outlet can discharge to the existing ground; if this is not possible, use a flexible slope drain and a sediment basin.
- Ideally, culverts should be placed below frost depth to avoid problems caused by frost heaving.
- Consider protecting culvert outlets from erosion and undermining by use of rock aprons, headwalls and wing walls, and/or plunge pools.

For additional information on culvert design methods, including the Rational Method for sizing, please refer to Cornell Local Roads Manual for Drainage: <http://www.clrp.cornell.edu/workshops/manuals/drainage.pdf>

STORM CULVERT RECOMMENDATIONS		
Type of road	NYS DOT design storm recommendation*	Cornell Local Roads design storm recommendation*
Town road with low traffic	50 years, but 10 or 25 years is acceptable if documented in design reports	10 year storm
Town road with high traffic or county road with low traffic	50 years, but 10 or 25 years is acceptable if documented in design reports	25 year storm
County road with high traffic	50 years, but 10 or 25 years is acceptable if documented in design reports	50 year storm
State roads and arterials	50 year storm	100 year storm

*For specifics for designs consult with the engineers/ Cornell Local Roads

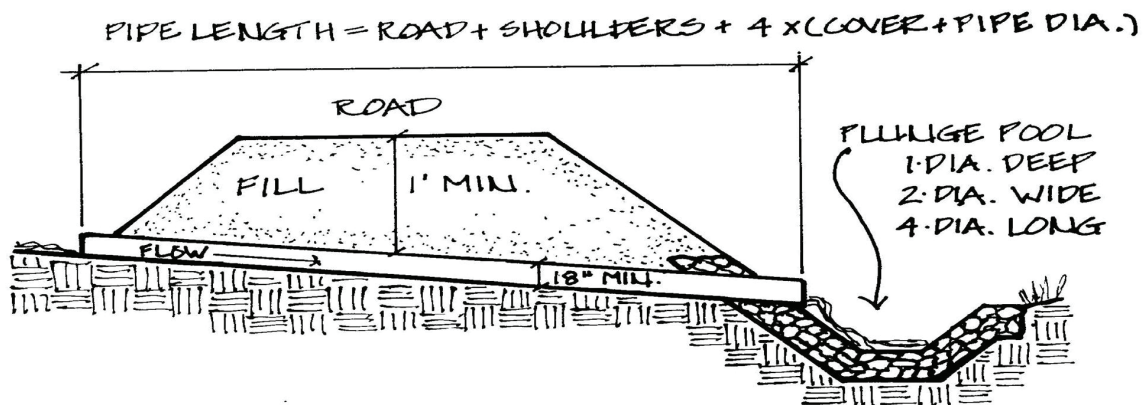

CULVERT PROFILE & CROSS SECTION

INSTALLATION & REPLACEMENT

The proper installation of a culvert is critical for ensuring its maximum performance. Issues that can arise from improper sizing and installation of a culvert include:

- Significant erosion at the outlets of culverts if they have not been properly designed or installed.
- Improperly sizing can cause upstream flood problems from water backing up at the road crossing.
- Water quality problems (i.e. turbidity) can result from improper grade and poor erosion controls during installation.

Please Note: these considerations are "rule of thumb" guidelines. Professional engineers

should be consulted in many instances when large culverts and structures are necessary. Permits, especially for in-stream construction will be required prior to the commencement of work. Contact your local SWCD or the NYSDEC for assistance and information.

Drainage Area	Culvert Diameter Needed
0-5 acres	12"
5-10 acres	18"
10-15 acres	24"
15-20 acres	30"
>20 acres	Detail design: consult a professional

Installation/Replacement:

Install sandbag dams in the stream and use a pump with riprap placed at the discharge to convey water around the excavation.

- Excavate the culvert area; remove the old culvert if doing a replacement.
- Excavate 10 feet downstream of the culvert discharge to a depth of 18" for riprap. Use erosion control precautions; permit may be required.
- Lay pipe up slope, starting at outlet end.
- Place culvert level with the streambed and backfill in one foot lifts, tamping the fill in place.
- Place 3 – 12 inch diameter riprap in the excavated outfall area tamping it level with the stream bottom.
- Place silt fence at the base of the bank slope and remove sandbag dam.
- Seed and mulch all disturbed areas.

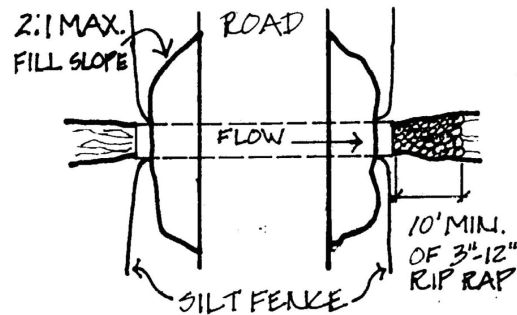
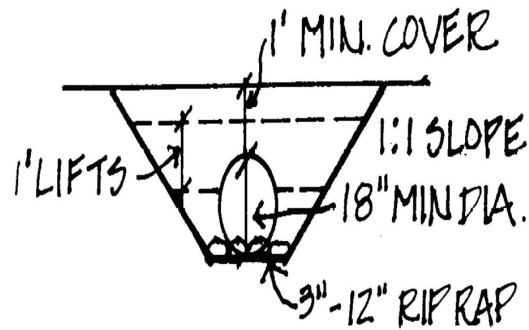
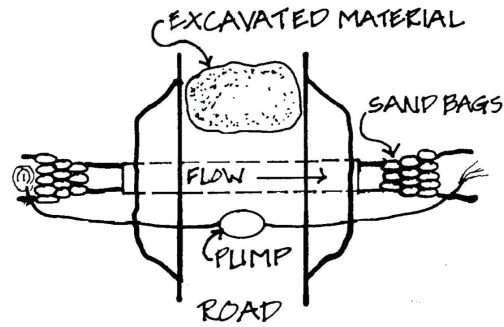

Dewatering

Prior to any culvert or road disturbance, install a sandbag dam, interlined with polyethylene sheeting in the stream to back up the water outside of the work zone. Use a water pump with riprap placed at the discharge to convey water around the excavation.

- Excavate the culvert area; remove the old culvert if doing replacement.
- Ensure that a stable, uniform foundation is provided regardless of the type of pipe being used. The foundation should be strong enough to carry the load of the backfill or embankment material placed on the pipe and still maintain the established grade.
- Excavate 10 feet downstream of the culvert discharge to a depth of 18" for riprap. Use

sediment and erosion control practices; a permit may be necessary.

- Lay pipe, working up slope, starting at outlet end.
- Place culvert level with the streambed and backfill in one foot lifts, tamping the fill in place.
- Place 3 – 12 inch diameter riprap in the excavated outfall area tamping it level with the stream bottom.
- Correctly install silt fence or coir logs at the base of the bank slope and remove sandbag dam.
- Stabilize all disturbed areas.

Aquatic Critter Friendly Culverts

A culvert installation should not change the conditions in the stream that existed prior to the installation.

- Numerous aquatic species move upstream and downstream to spawn and meet habitat needs.
- Culverts can impede passage by the following conditions:
 - ⇒ Vertical barrier – i.e. fish must jump too high if culvert is perched.
 - ⇒ Water velocity too fast over the given length of the culvert in relation to fish capabilities.
 - ⇒ Inadequate water depth in culvert.
 - ⇒ Icing and debris problems.
 - ⇒ Culvert design does not accommodate the size and species of fish passing through the structure.
- When selecting a new stream crossing site to install a culvert, the ideal site will have no sudden increase or decrease in gradient and not be located at or near a bend in the stream. This will minimize the potential for frequent or difficult maintenance.
- Use bridges, bottomless arches or partially buried culverts in areas where fish passage is an important consideration.
- Corrugated steel or plastic culverts decrease water velocities and supply resting areas for migrating fish.
- Make sure culvert diameters are adequate to pass maximum expected design flows.
- Design culverts so that water velocities passing through the pipe are equal to water velocities in the stream.
- Provide resting pools at culvert inlet and outlet for culverts installed across streams with high gradients.

Contact your local SWCD, The Nature Conservancy, AsRA, and/or NYSDEC for assistance with stream crossings and permitting. (See **Resources** for contact information).

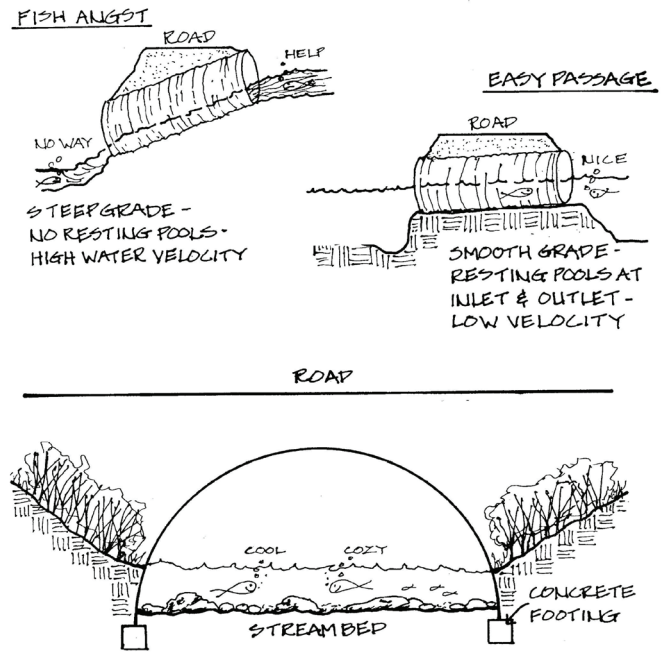

BOTTOMLESS ARCH CULVERT

Intersections of Public Roads with Private Roads/Drive

To ensure the integrity of roads and ditches it may be necessary to provide culverts or other structures where private roads or drives intersect with public roads.

- Culverts on private roads/drives should follow the same criteria in placement and sizing as recommended for public roads.
- An open top culvert may be used when drainage is entering a public road by way of the private road surface. This open top culvert can be used to divert the drainage into the existing ditch.
- If necessary, towns should consider the adoption of policies and standards for installing and maintaining driveway culverts. (See **Resources** for more information.)

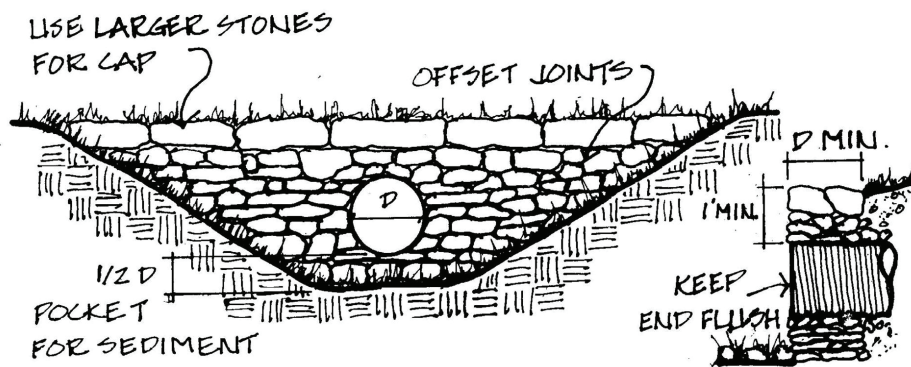

HEADER

Headers or Headwalls

Headers mark the location of a culvert, protect the culvert from damage during grading, plowing and ditch cleaning, increase the hydraulic efficiency, and prevent erosion around the culvert inlet.

- Headers can be used when hydraulic efficiency needs to be increased by 10% or less if installing a header will be easier than replacing the culvert.
- Headers should be flush with the end of the culvert.
- Header extensions (wings) help direct the flow of runoff into the culvert, preventing water from flowing in undesirable directions.

Cleaning & Maintenance

Avoid clogging, collapsing, washouts, and settlement by practicing preventative maintenance.

- Inspect culverts as often as possible, but at least in the spring, fall and after major storms.
- Mark or inventory culverts so they do not get missed during inspections.
- Inspect under drains and keep outlets of under drains clear.
- Check culverts during freezing weather and take action if the culverts start to freeze.
- Use a high-pressure hose to flush most plugged culverts (with water).
- Flush culverts from the outlet end.
- Clean the outlet ditch after flushing.
- Thaw frozen culverts by using steam, high-pressure water, ice augers, calcium chloride.

- Check culvert inlet for erosion and to ensure the water is flowing in the pipe and not around it; if some water goes around the culvert it can undermine the bedding and the culvert will fail (e.g. "piping").
- Replace culverts with the same size pipe if it is handling the flow adequately; you may need to consider future development and changes in storm patterns and assess need for upsizing.
- Increase culvert size as development along a road increases or if the culvert is more than half full during high flows.

"John's Welder's" Method for Removing Ice Build Up

The "John's Welder" method for removing ice buildup, extracted from a Maine drainage manual, is typically reserved for culverts that experience recurring ice blockage. Suspend a 1/4-inch diameter wire through the pipes that freeze most often. When ice blocks the pipe, hook up a portable welder to the wire and melt the ice around it enough to start the water flowing again. The moving water continues to increase the flow opening. The ends of the wire are attached to steel posts in the embankment at each end of the culvert. The wire remains suspended in the pipe permanently until a freeze-up calls for removing the wire from the posts and hooking the welder up again.

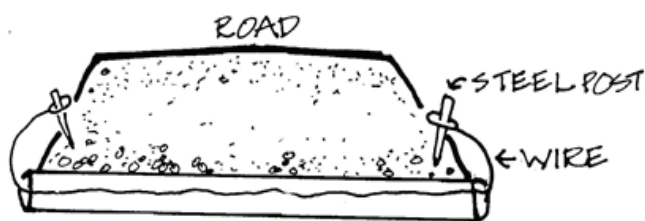

Special Environmental Considerations for Culvert Installation

Wetlands

Some stream bottoms qualify as a wetland, if they have identifiable aquatic vegetation. Wetland impacts must be avoided or minimized. Depending on where the project is located there may be jurisdiction from the NYSDEC, US Army Corps of Engineers, Adirondack Park agency or the local municipality. Seek guidance from your local County SWCD.

Fish and Aquatic Organisms

The culvert should be set so that the stream is not fragmented and fish and other aquatic organisms can migrate upstream and down-stream during

low-flow conditions. This requires that the inside bottom of the culvert be at least 6" (10%-20% of culvert diameter) below the final stream bed. In addition, the structure should be rocked on both the upstream and downstream margins, as well as the downstream face in the water. The desired end-result is that during high-flow conditions, the currents don't cause a large pool to develop downstream of the edge of the structure, which creates an impassable barrier to aquatic organisms during low flows in the fall.

Spawning Periods

To avoid spawning periods, do in-stream work between May 1 to September 30. However, to be safe, consult your local SWCD or the NYSDEC about your particular stream.

Culvert Maintenance

Outside of the Culvert		
What you observe	○ What the reason may be	How to fix it
Scouring/erosion at the inlet	<ul style="list-style-type: none"> ○ Ditch is too steeply graded ○ Culvert is poorly located or aligned ○ Culvert is plugged ○ Culvert is too small ○ No headwalls 	<ul style="list-style-type: none"> ⇒ Line the inlet with stone ⇒ Properly align culvert ⇒ Clean/flush the culvert ⇒ Replace with larger culvert ⇒ Install headwalls
Scouring/erosion at the outlet	<ul style="list-style-type: none"> ○ Culvert is sloped too much ○ Culvert is too small ○ Culvert is too high above ground (perched) 	<ul style="list-style-type: none"> ⇒ Decrease slope of culvert ⇒ Check size and replace with larger pipe if necessary ⇒ Build a stone splash pad
"Ponded" /puddled water	○ Inlet is too high	⇒ Reset the pipe to match the inlet to the channel bottom
	○ Ditch grade is too flat	<ul style="list-style-type: none"> ⇒ Regrade the ditch to maintain correct flow ⇒ Install a larger culvert
Dented or crushed ends	○ Vehicles or snowplows are hitting the ends	<ul style="list-style-type: none"> ⇒ Fix culvert ends and mark them ⇒ Install stone header to protect them from damage ⇒ Add extension to lengthen culvert

Outside of the Culvert		
What you observe	○ What the reason may be	How to fix it
Heavy corrosion	○ Water flowing through the culvert is acidic	⇒ Install a sleeve of PVC in the existing pipe or replace the steel culvert with a non-corrosive material (PVC, aluminum, concrete)
Water piping round the culvert	○ Culvert is incorrectly installed, causing water to flow along the outside surface of the pipe	⇒ Reinstall the pipe on a suitable, properly compacted bedding ⇒ Install a headwall
Inside of the Culvert		
What you observe	○ What the reason may be	How to fix it
Sediment buildup in the culvert	○ Not enough slope ○ An erosion source exists upstream from culvert	⇒ Reinstall culvert with a slope of at least 1/4" drop per foot ⇒ Locate and stabilize upstream erosion site
Sediment buildup above culvert inlet	○ Culvert is too small ○ An erosion source exists upstream from culvert	⇒ Replace existing culvert with a larger one ⇒ Locate and stabilize uphill erosion site
Objects blocking the culvert	○ Debris traveling from the ditch to the culvert	⇒ Remove blockage ⇒ For road ditch culverts - Install check dams uphill of the culvert
Sagging bottom	○ Foundation material has settled or has low bearing capacity ○ Bottom of culvert has rotted out	⇒ Reinstall culvert with suitable and properly compacted foundation material ⇒ Replace culvert
Crushed top	○ Not enough cover ○ Soil around the walls is not compacted ○ Traffic loads are too heavy	⇒ Add cover ⇒ Reinstall culvert deeper and/or with suitable and properly compacted bedding material ⇒ Replace with stronger culvert
Eroding side banks at culvert inlet and outlet	○ Culvert is improperly aligned with water flow ○ Culvert is too small	⇒ Realign culvert to match flow of water ⇒ Replace existing culvert with a larger one ⇒ Install headers and wing walls

Inside of the Culvert		
What you observe	○ What the reason may be	How to fix it
Water is backed up at culvert inlet	○ Culvert is too small	⇒ Replace existing culvert with larger one
Culvert is narrower than “bank full” width of live stream	○ Culvert is too small	⇒ Measure the “bank full” or channel width at a stable stream cross section and install a new culvert at least as wide in diameter.
Culvert has washed out	○ Culvert is too small, at the wrong angle to the road, has unstable or non-existent headers	⇒ Replace existing culvert with a larger one ⇒ Install headers on new culvert ⇒ Do not reinstall the same culvert or a new one that is the same size as the one that washed out
<i>from VT Roads & Culvert Fact Sheet</i>		

Drainage Law for New York State

Reasonable use as used in New York State is most closely a modification of English common law. Water is a common enemy. A landowner can improve the land to improve drainage as long as doing so would be a reasonable use for the type of land. But, the landowner cannot improve land so as to cause additional volumes of water to flow onto neighboring land without getting permission and showing justifiable reasons. This includes local governments. However, repairs and replacements of existing drainage structures that are performed as necessary to maintain a road are an acceptable reasonable use of land by a highway department.

Information on NYS Drainage Laws is located at:

https://www.dot.ny.gov/divisions/engineering/design/dqab/hdm/hdm-repository/chapt_08.pdf

Outlet Protection

Outlet protection controls erosion at the outlet of a culvert or a channel. It works by reducing the velocity of water and dissipating its energy. Outlet protection should be installed at all pipes, culverts, swales, diversions, and other water conveyances where the velocity of the water may cause erosion at the outlet and in the receiving channel. Depending on the situation, there are a variety of outlet structures that can be used.

General Outlet Protection Principles

- ✓ Install at all pipe, culvert, swales and other water diversions, where water velocity may cause erosion. Consider seasonal flows.
- ✓ Design and size outlet protection for anticipated water velocities.
- ✓ Conduct regular maintenance and inspect periodically.

Importance to Water Quality

An outlet protection structure reduces water velocity helping to control erosion and limit sedimentation. After passing through a structure, water should be directed to areas with moderate slopes and vegetative filter zone before entering surface waters. This type of action is referred to as "daylighting". This process allows most of the sediment and other pollutants to be removed before the runoff enters any receiving waterbody.

STRUCTURAL OUTLET PROTECTION

Turnouts

Extensions of ditches which direct water away from the road edge to filtering areas whenever possible. Use of turnouts will not only protect water quality, but will also collect gravel for reuse.

- Follow culvert recommendations for spacing of turnouts.
- Use only in area where the water will flow to a filtering area well away from the road and surface waters.

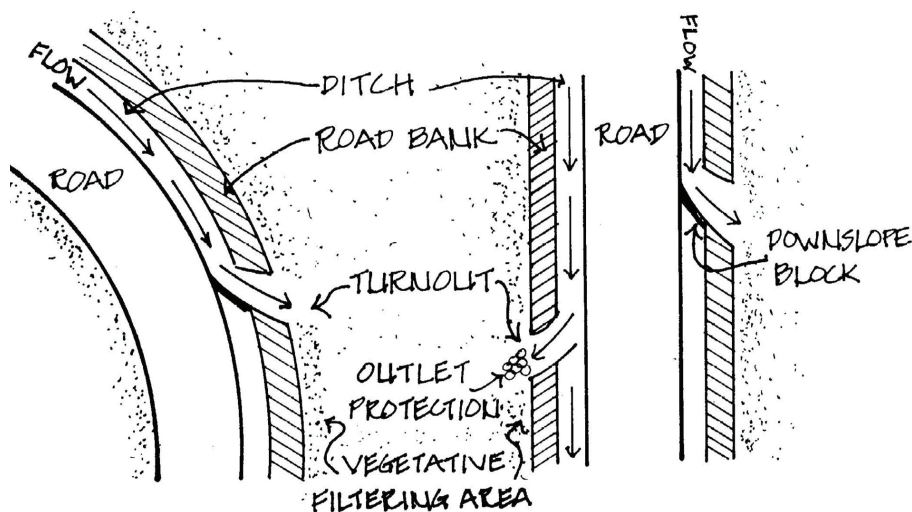

TURNOUTS

Rock Apron

An area lined with riprap used to discharge water from culverts to existing ground.

- Provides culvert outlet protection by reducing water velocity flows.
- Use only where there is an adequate vegetative filter strip.
- Discharging of a culvert to a fill slope, will require a conveyance channel before the water reaches the rock apron.
- The size and placement of riprap in the apron is dependent upon the diameter of the culvert as well as on expected water velocity.

Rock Apron Specifications					
Culvert Diameter (D)	Riprap Size	T (in.)	N (ft.)	W (ft.)	L (ft.)
18 inches	(3-12 inch)	18	4.5	14.5	10.0
24 inches	(3-12 inch)	18	6.0	20.0	14.0

D= diameter of culvert
 T= depth of stone in apron
 N= width of apron near culvert
 W= width at downhill end of apron
 L= length of apron

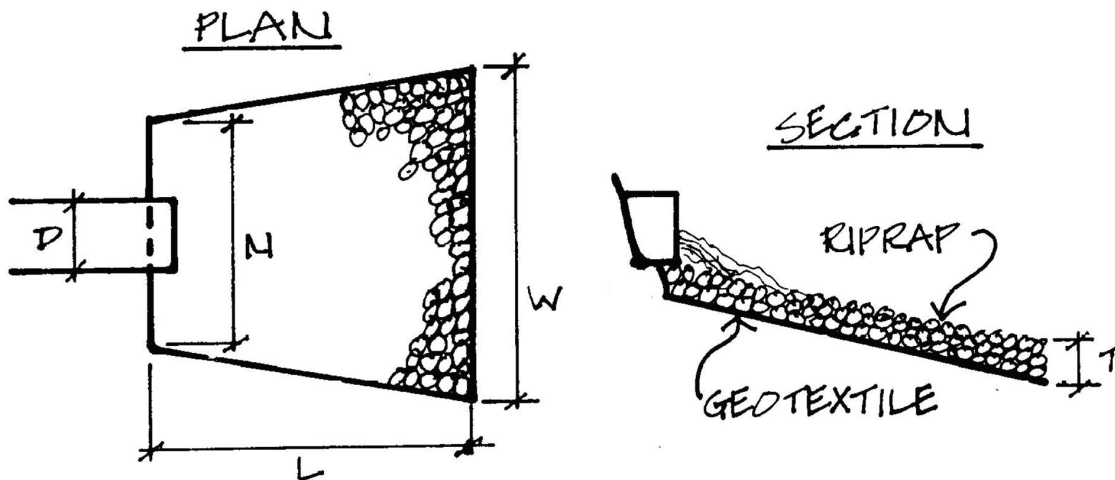

ROCK APRON

Riprap Conveyance Channel

A riprap channel is used to remove sediment and to keep the channel from eroding while carrying runoff from a culvert or a ditch.

- Use in areas with filled slopes or with steep slopes where erosion may otherwise occur.
- Use in areas without adequate vegetative filter strips, and where an outlet must go directly into surface waters.

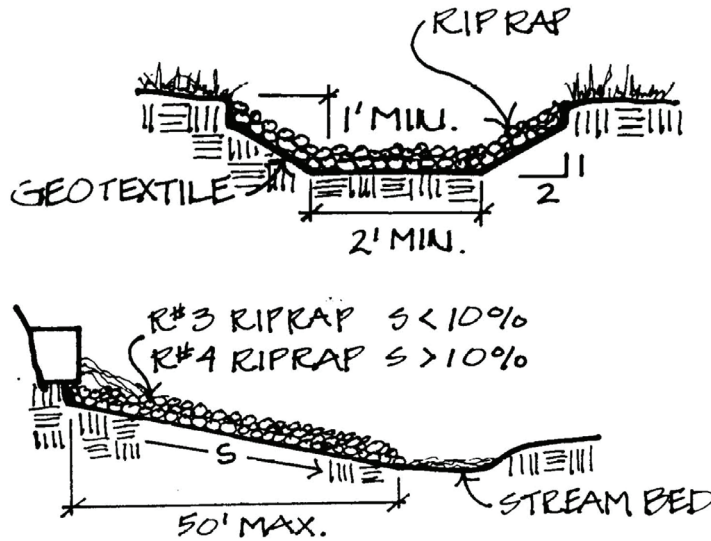

RIPRAP CONVEYANCE CHANNEL

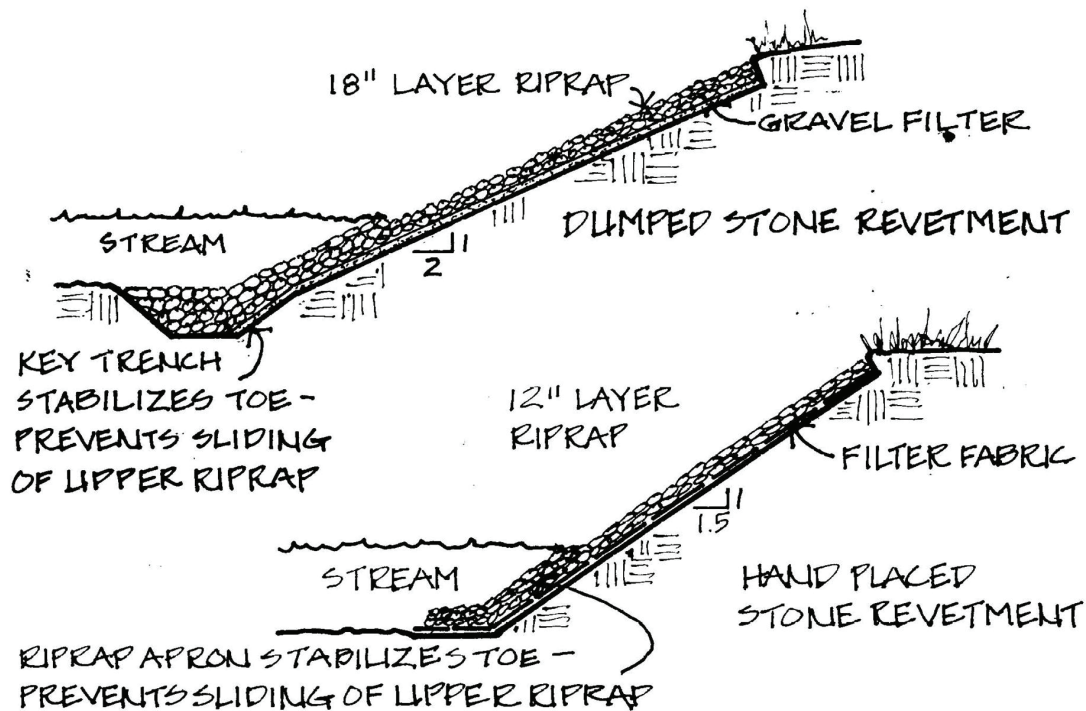

RIPRAP REVETMENT

Splash/Plunge Pools

Splash or plunge pools control erosion at the outlet of a channel or conduit; and detain water, which allows sediment to settle out. They work by reducing the water's energy and velocity by providing storage of runoff. They should be installed at all pipes, culverts, swales, or diversions and in the receiving channel where the velocity of the flow may cause erosion at the outlet. Riprap is the preferred material. Splash pools are good for removing sediments from areas with concentrated flows and areas without adequate vegetative filter zones.

- Limited to areas with less than 10% slope.
- Consolidates sediment for easier removal.
- Reduces energy and velocity of flows by providing storage of runoff.
- Can allow for ground water recharge.
- Maintain (clean out) when pool area is one third filled with sediment.
- Locate the pool so that mechanized cleaning is possible.
- See pool capacity requirements chart for sizing.

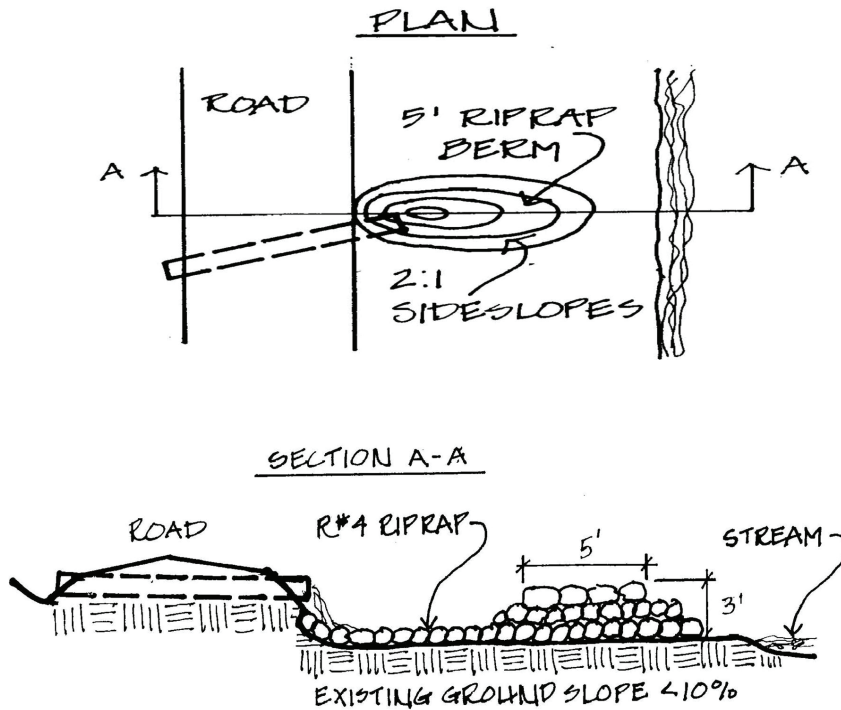

SPLASH/PLUNGE POOL

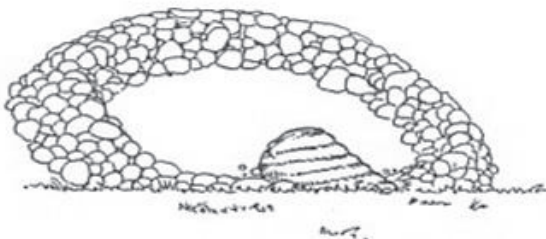

PLUNGE POOL

Splash/Plunge Pool Capacity Requirements		
Distance Between Culverts	Pool Capacity (cu ft.)	
	Crowned Road	Banked Road
500	230	460
400	180	360
350	160	320
300	140	280
250	120	240
200	100	200

NON-STRUCTURAL OUTLET PROTECTION

Filter Zones

Filter zones, or natural “buffer” zones, are undisturbed vegetated areas that slow water using vegetation to reduce erosion and runoff velocities. They are often used to separate roads from sensitive areas such as streams, wetlands, and lakes. Natural buffer zones provide critical wildlife habitat adjacent to streams and wetlands, as well as assisting in erosion control, especially on unstable steep slopes. Excessive runoff or sediment may damage the filtering area and require other types of structural controls.

- Filter zones act as natural sediment traps, as well as a visibility and noise screen.
- They have low maintenance requirements and are a low cost option when using existing vegetation.
- They are the preferred method of slowing and filtering water before it enters surface waters.
- If there is little or no vegetation between the road and stream, consider creating or

enhancing a filter zone by planting a diversity of native grasses, shrubs, and trees. This will increase the filtration of road runoff before it reaches the water body.

- Use only in areas where the water will flow to a filtering area well away from the road and surface waters.

Tips for Filter Zones

- ✓ Fence or flag clearing limits and keep all construction equipment and debris out of the natural area.
- ✓ Keep all excavations outside the drip line of trees and shrubs.
- ✓ Routine and careful maintenance such as mowing, fertilizing, and pruning is important to ensure healthy vegetation. Appropriate maintenance methods will be dependent on the species of plants and trees involved, soil types, and climatic conditions.
- ✓ Establish new filter zones using appropriate native species for the site.

Matrix of Outlet Protection BMPs		
What you are trying to achieve	How to achieve it	Consideration for use
Development of a natural sediment filter Improved appearance	<ul style="list-style-type: none"> ○ Natural filter zones ○ Enhanced or created filter zones 	<ul style="list-style-type: none"> ✓ Little maintenance required Low cost.
Slow velocity of water at outlet	<ul style="list-style-type: none"> ○ Rock apron 	<ul style="list-style-type: none"> ✓ Use only where there is an adequate filter strip between outlet and body of water.
Control/reduce erosion at outlet	<ul style="list-style-type: none"> ○ Rip rap of the conveyance channel* 	<ul style="list-style-type: none"> ✓ Use on fill slopes, step slopes where outlet flows close to surface waters.
Settle out sediments	<ul style="list-style-type: none"> ○ Splash/plunge pool* ○ Level spreader* 	<ul style="list-style-type: none"> ✓ Use where storage of runoff is necessary before discharge. ✓ Changes concentrated flow into sheet flow.
* May require site-specific engineering assistance Contact your local SWCD or NYSDEC		

Bank Stabilization

Bank stabilization uses vegetative or structural means to prevent erosion or failure of a slope. These terms have different definitions, as well as causes. Bank failure occurs when an entire section of the bank slides to the toe of the slope. It can be caused by an increase of load on top of the bank, swelling of clays due to absorption of water, pressure of ground water from within the bank, minor movements of the soil, or changes in stream channel shape.

General Bank Stabilization Principles

- ✓ Carefully evaluate the site and follow design considerations when selecting appropriate stabilization techniques.
- ✓ Use living plants adapted to the site whenever possible.
- ✓ Perform regular maintenance and inspect new stabilization projects frequently.

Vegetation – Seeding

Seeding is the most efficient and inexpensive method to stabilize a bank or any areas of exposed soils, and should be used wherever possible. Grass and legumes will slow the movement of water, allowing more water to seep into the ground and minimizing the impact of runoff.

- Areas to be seeded should have a maximum 2H:1V slope.
- Seed areas **as soon as possible** after disturbance; this may even need to be done on a temporary basis.
- The surface should be left rough, to reduce water velocity and to help hold seed and mulch.
- If necessary, place sod in areas with unstable soil.
- Erosion control blankets (rolls of degradable netting embedded with mulch or straw) can be used on steep slopes to better hold seed and soil in place.
- Spread at least 3 inches of topsoil over the area to be seeded.

Importance to Water Quality

Stabilization of banks along roads and streams will assist in preventing bank erosion and failure, which contributes considerable amounts of sediment to our waters. Preventing erosion and bank failures can also reduce the need for expensive road repairs.

- Finish grading should be done after topsoil is spread.
- Add soil amendments (lime, low Phosphorus fertilizer, etc.) in the area as needed according to the soil conditions.
- Harrow or rake soil amendments into soil to a depth of two inches.
- Select a seed mixture appropriate for site preferably a native mix. (Conservation or Lake Champlain Watershed mixes are suitable for most areas.)
- Broadcast seed evenly over the prepared area by either hand broadcasting or hydroseeding.
- Mulch after seeding with straw and/or hydromulch to a depth of 3 inches. If no mulch is to be applied, roll, rake or brush to lightly cover the seed.
- If a tackifier is not utilized, mulch can be anchored to soil by using a disk harrow or sheep foot roller.



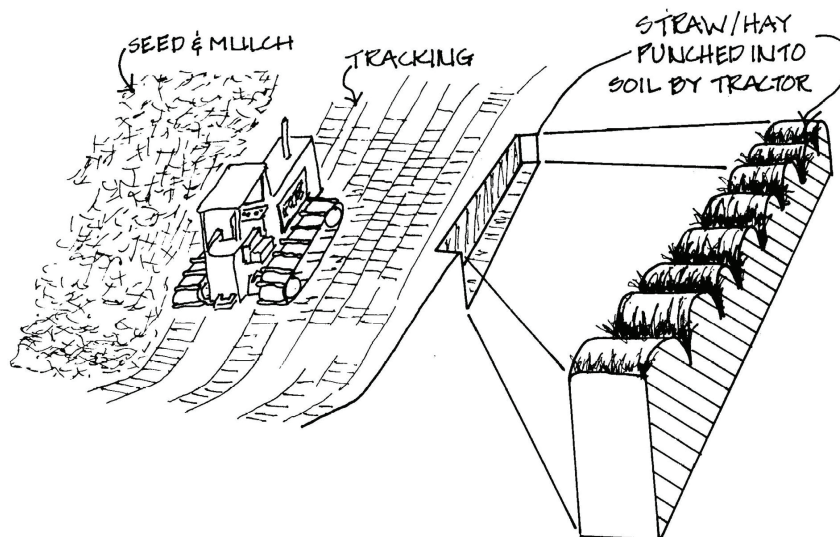

SURFACE ROUGHENING

Matrix of Bank Stabilization BMPs			
Bank Stabilization Technique	Examples	Appropriate Uses	The Role of Vegetation
Grading Techniques	<ul style="list-style-type: none"> ○ Cut and fill ○ Notching ○ Terracing ○ Counterweights 	On slopes no greater than 2H:1V and where structural stabilization techniques are not needed	Once reestablished, it is considered permanent stabilization
Vegetative	<ul style="list-style-type: none"> ○ Sowing grass seed ○ Hydroseeding 	Use on slopes where slight to moderate stabilization is needed to control water and wind erosion and minimize frost effects	To control weeds, bind and retain soil, filter soil from runoff, intercept raindrops, and maintain infiltration
Bioengineering Techniques* (Trees & Shrubs)	<ul style="list-style-type: none"> ○ Live Fascine ○ Live Stakes ○ Brush layering ○ Sprigs & Plugs 	Controls rills and gullies Controls movement of soil Filters sediments	Same as listed above, also reinforces soil, minimizes downslope movement of soil. Improves appearance
Combinations of techniques	<ul style="list-style-type: none"> ○ Live Crib wall ○ Vegetated Gabion ○ Vegetated Rock Wall ○ Joint Planting 	Same as listed above, also controls erosion on cut and fill slopes that are subject to scour and erosion	Same as above, also reinforces soil. Minimizes downslope movement of soil, improves appearance
Structural*	<ul style="list-style-type: none"> ○ Rock Wall ○ Gabion Baskets ○ Rip rap ○ Geotextiles, mats & blankets 	Use on eroding slopes with seepage problems and/or slopes with non-cohesive soils	Not applicable

* May require an engineer

Vegetation – Shrubs and Trees

The use of live plant materials, such as shrubs and trees to control erosion and stabilize slopes, is commonly referred to as *bioengineering*. These techniques can be used to stabilize steep slopes and stream banks, and create a natural vegetative filter zone. It is recommended to utilize native vegetation for stabilization. For stream bank stabilization, specialized design and rigorous environmental permitting will be required. Consult your SWCD for permit requirements.

- Deeply rooted woody species provide greater protection against bank erosion problems.
- Commonly used stabilization plants include: willows and dogwoods.
- Techniques for stabilizing banks with woody plants include live fascines/wattles/bundles, live stakes, brushlayering, and sprigs/ plugs.

Live Fascines

Fascines, also called wattles or bundles, are long bundles of live branches installed in shallow trenches, 5 to 30 feet in length and 6 to 8 inches in diameter. They are generally tied together with growing tips oriented the same direction and tops evenly distributed through the length of the bundle. Fascines can be used on steep slopes (1H: 1V) to protect slopes from shallow slides. Commonly used plants for live fascines include willows and dogwoods.

- Set into a 12 to 18 inch deep trench dug along the contour of the slope, working from the base of the slope upwards.
- Secure with live stakes and stout dead stakes.
- Cut vegetation during the dormant period (November to early March.) Install bundles the same day as they are harvested.

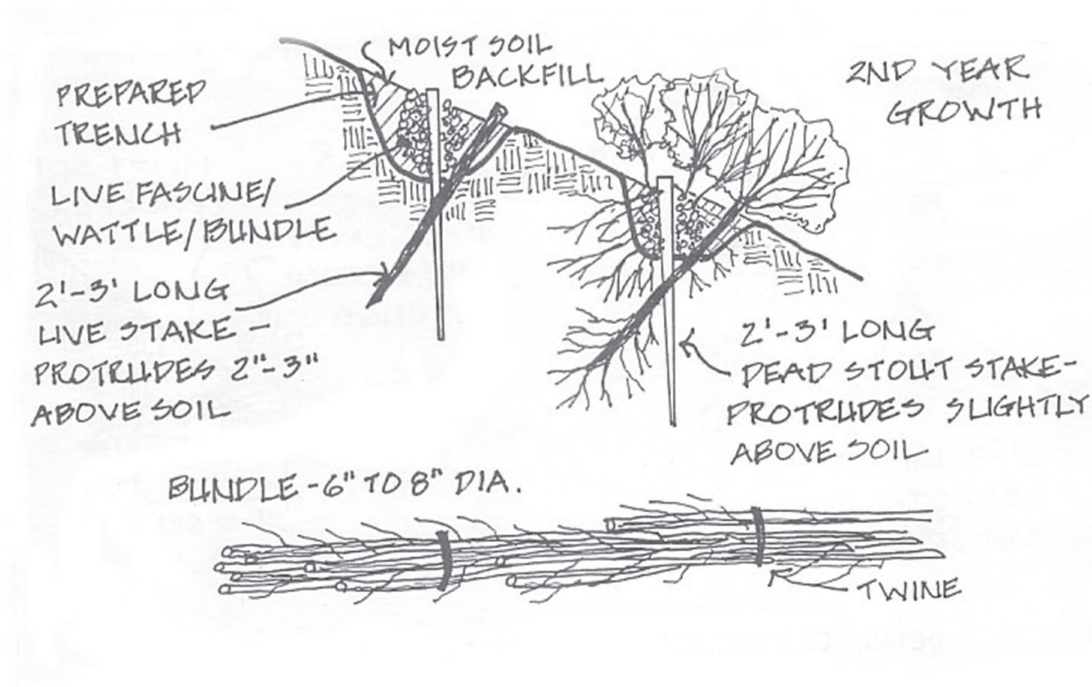

LIVE FASCINES/WATTLES/BUNDLES

Live Stakes

Live stakes are cuttings of branches, usually ½ to 1½ inches in diameter and 2 to 3 feet long, taken from living, woody plants capable of quickly and easily taking root. This is an inexpensive method that can be used when time is limited and the site is relatively uncomplicated. Live stakes are usually used on moderate slopes (4H:1V or less) of original bank soil (not fill) where there is little active erosion or chance of bank washout. Dogwood species are capable of rooting, but willow species work best. Live stakes must be used when the plant is dormant.

- Branches should be cleanly removed from the stakes, and the basal ends of stakes should be cut at an angle for easy insertion into the soil.
- Stakes are tamped into the ground at right angles to the slope along the contour, with buds oriented up.
- Plant in alternating grids with 2 to 4 stakes per square yard.
- Plant stakes the same day as cut (spring, winter, or fall).

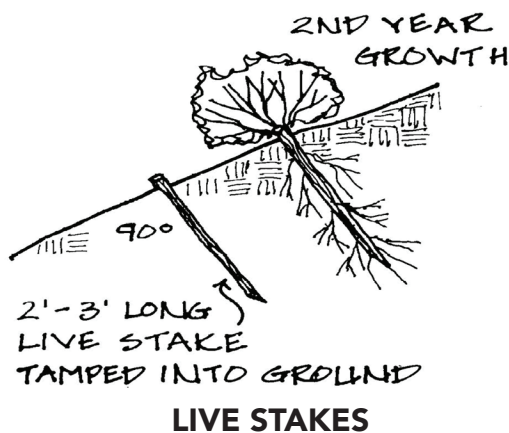

Brushlayering

Brushlayering is a technique whereby live branches, ½ to 2 inches in diameter and 3 to 4 feet long, are placed perpendicular to the slope with growing tips outward. Brushlayering is used to break up slopes into a series of shorter slopes.

Small 2 to 3 foot wide benches, angled slightly higher at the outside, are excavated along the contour starting at the toe of the slope and working upward.

- Branch cuttings are placed on the bench in a crisscross or overlapping manner with cut end into bank perpendicular to slope.
- Backfill soil on top of branches and compact.
- Plant branches the same day as cut during dormant periods (spring, winter, or fall).

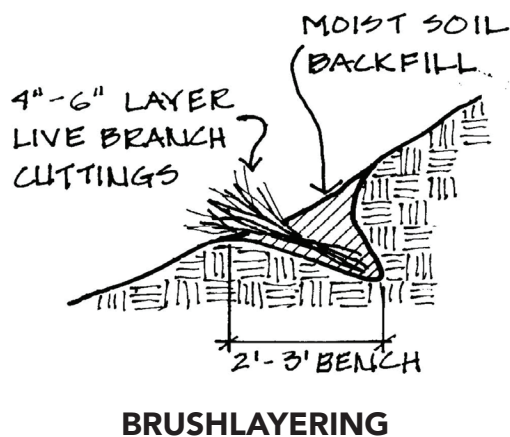

Sprigs or Plugs

Sprigs or plugs are individual plant stems with roots; they can be seedlings or rooted cuttings. Sprigs and plugs are a low cost, quick growing option that can be planted anytime of year.

- Place in hole that is dug large enough to accommodate the roots and tamp soil down around the plant.
- Plant in alternating grids with plants 18" to 36" apart.
- They are often used on filled slopes in conjunction with special fiber rolls.
- Rooted shrubs from a nursery may also be planted. These are more reliable, but more expensive.

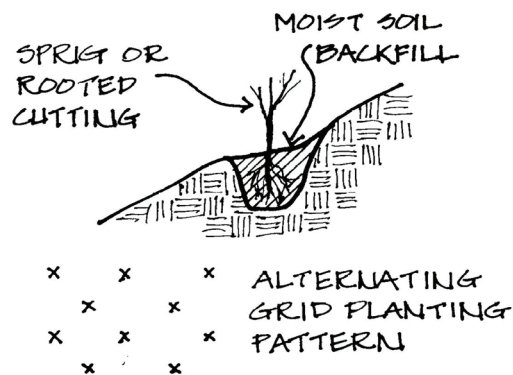

Grading Techniques

Proper grading or regrading of slopes can often stabilize banks without the use of structures. Grading slopes to a maximum 2:1 slope will help to stabilize the bank. Techniques for grading include:

Terracing: Benches that can be constructed on slopes that are excessively long and steep, which will provide near level areas that intercept and divert water.

Backslope terraces inwards toward the slope to intercept water and prevent erosion of terrace.

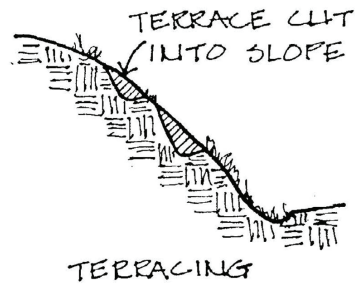

Counterweight: A one level bench and slope that can be added next to a steep, failing bank to stabilize the bank and prevent continued sliding.

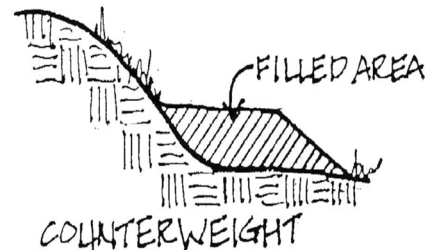

Cut and/or Fill: The removal or addition of soil to the bank to create the desired 2:1 or flatter slope. Often removing less stable soils and replacing them in the process of regrading the slope is preferred.

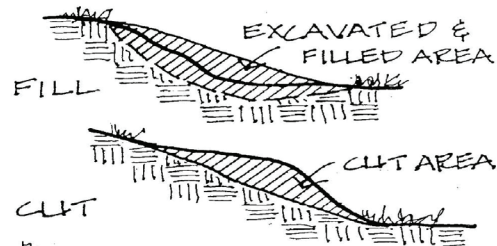

Notching or Keying: A "V" or trapezoid shaped cut made in the existing ground to help further stabilize the slope.

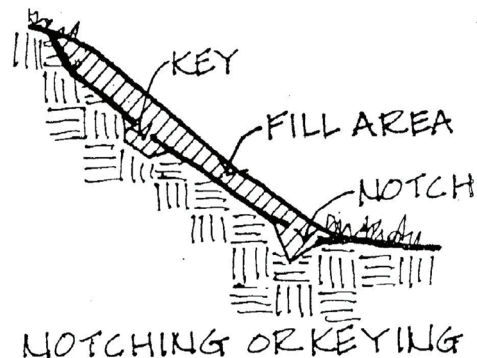

Structures - Walls

Gabions are rectangular wire mesh "baskets" filled with stone, stacked atop one another to form a gravity-type retaining wall. Gabions depend on the interlocking of the individual stones and rocks within the basket for internal stability. They are an easy-to-use method for slowing the velocity of runoff and protecting slopes from erosion and hillside movement. Gabions are more expensive than either vegetated slopes or riprap. Though very unnatural in appearance, they can be made more attractive by establishing vegetation in the spaces between the rocks or on the outside of the baskets (natural plants).

- Gabions are permeable, allowing water to seep through and aiding in the removal of sediments.

- Gabions can be stacked or terraced.
- Gabions can be combined with woody vegetation for stabilization and aesthetics.
- Use filter fabric between soil and gabions to prevent soil from washing out through stones.

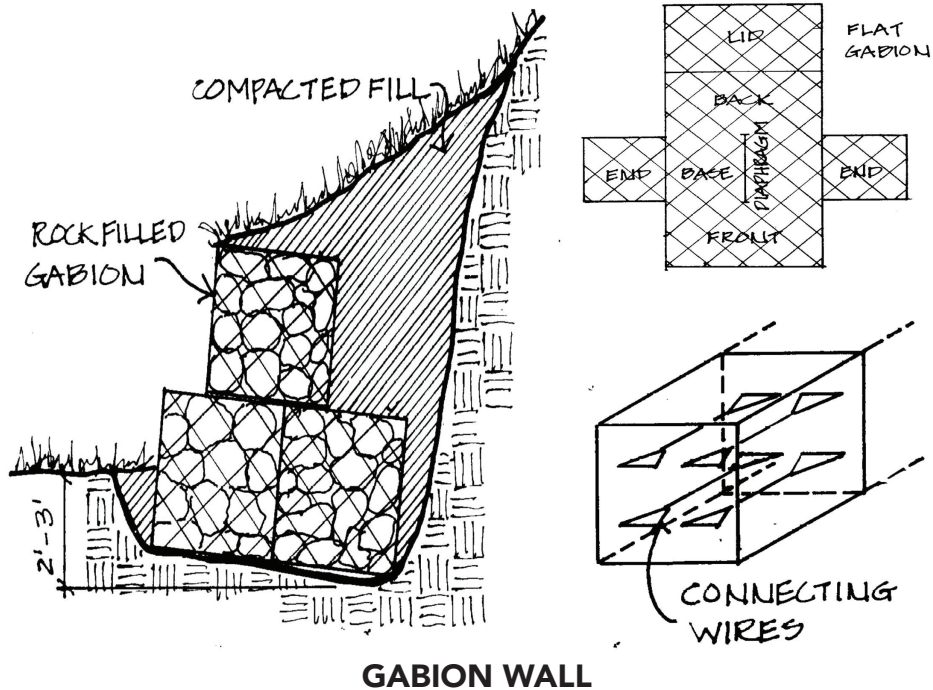

GABION WALL

Log or Timber Cribs are square or rectangular structures made of logs or treated timber and filled with soil and used as retaining walls.

- Live branches can be planted in the crib to assist with stabilization.

(See Combination of Techniques.)

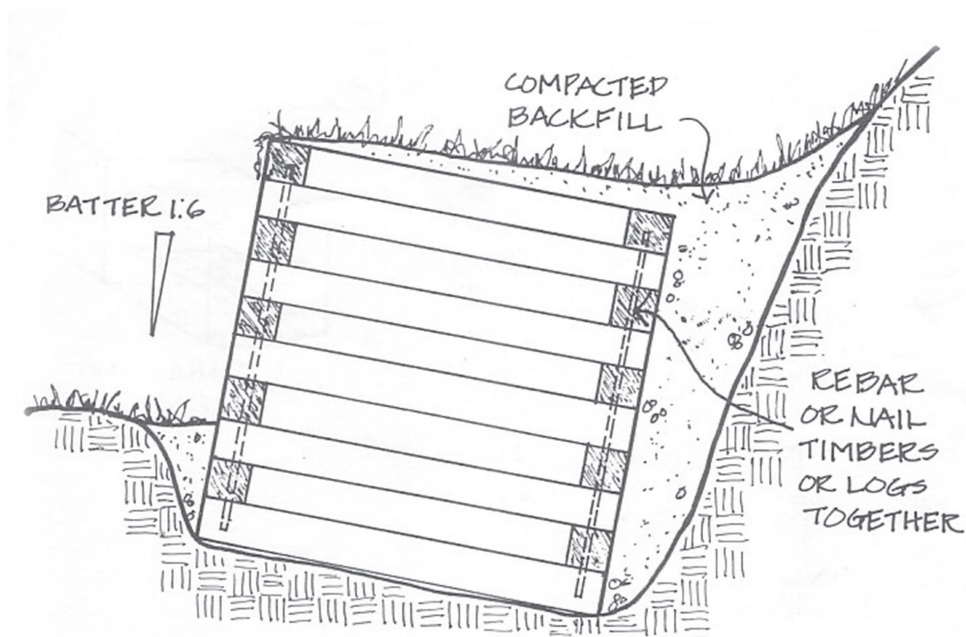

LOG OR TIMBER CRIB

Structures – Revetment Systems

Riprap can be placed on roadside slopes and stream banks where vegetation does not adequately prevent soil loss due to erosion and filter sediment. *Note: Specialized designs and wetland permits may be required when using riprap on stream banks.*

- Size of riprap is dependent on quantity and velocity of water flow; generally, top of riprap (min. thickness=max. rock size), bottom of riprap (min. thickness=2 x max. rock size).
- Used on very steep slopes, at sharp turns in streams (especially those with widely fluctuating flows), and where a bridge or culvert restricts water flow.
- Always contact a Stream Alteration Engineer, US Fish and Wildlife Service, or the local SWCD about design and installation of riprap on stream banks. (See **Resources**)
- The habitat and aesthetic value is relatively low unless it is enhanced with vegetation.
- Use angular riprap stone. Slate or round stone will slide very easily.
- Install filter fabric under riprap to prevent soil from washing out, unless advised otherwise by the installation design.
- Consider plantings within the riprap to add stability, natural aesthetics and wildlife habitat to the site.
- Consider adding vegetation at the top of the bank- (above the high water level) and stabilizing with riprap at the toe of the slope where moving water will flow.

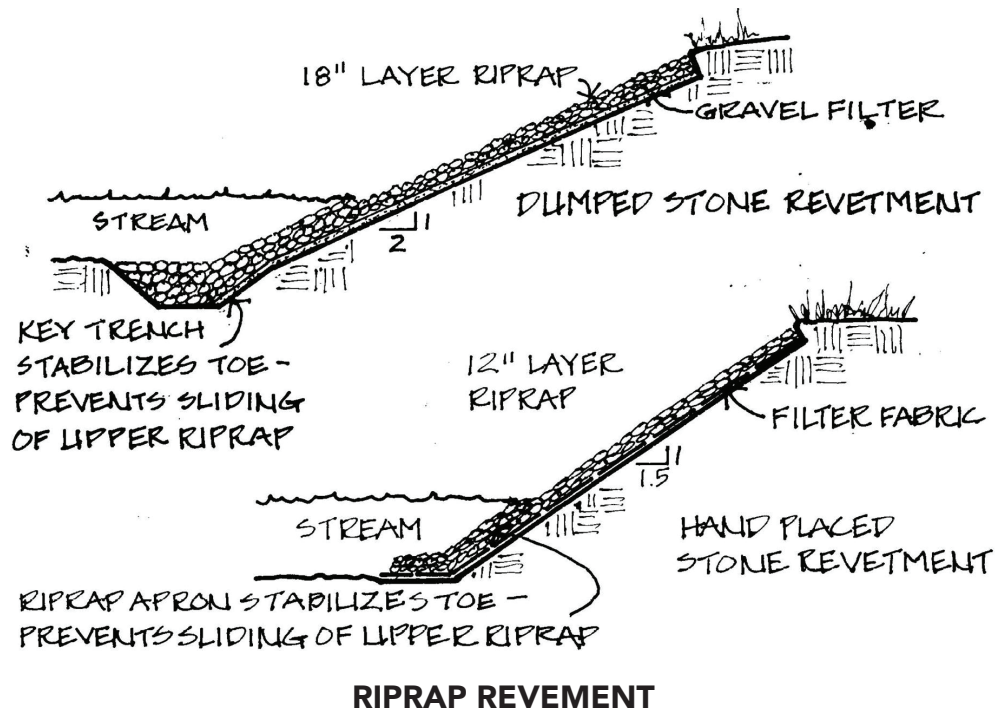

COMBINATION OF TECHNIQUES

Combinations utilize vegetative and structural components to stabilize steep banks in an integrated and complementary manner. Combinations can be used when one component alone will not provide the necessary slope protection and stabilization.

Techniques include:

Live Cribwall

A live cribwall is a rectangular framework made of logs or timbers, rock, or woody cuttings. This technique can be used on roadside slopes and stream banks. Use at the base of the slope where a low wall, not higher than 6 feet, is required.

- Place logs or timbers in an alternating manner, leaving space for live branch cuttings.
- Branch cuttings should be long enough to reach the undisturbed soil at the back of the crib.
- Cover each layer of branches with soil, then compact.
- If used to repair stream bank, place two to three feet below the streambed on a gravel base and ensure cribs are uniform with the existing bank, not projecting into stream.
- Timbers provide structural support while plants take root and use half as much wood as in a timber or log crib, making it a less expensive and more natural alternative after it has begun to grow.
- Cribwalls can also be constructed in a step fashion, creating planting areas.

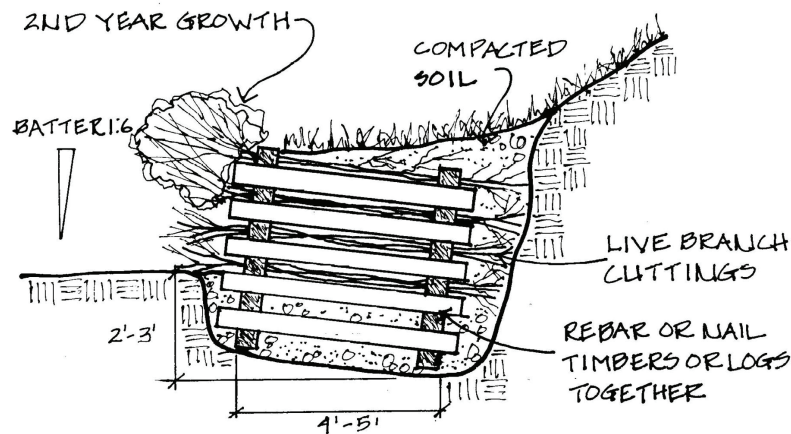

LIVE CRIBWALL

Vegetated Gabion

A gabion wall can be combined with live branches, as used in brushlayering. "Greening" a gabion wall in this way will provide aesthetic and habitat enhancement to the wall.

- Backfill between each layer of gabions and place live branch cuttings on backfill.
- Place cuttings at an angle of at least 10% so they can take root.
- The branches root in gabions and into the slope, binding the gabions to the slope.

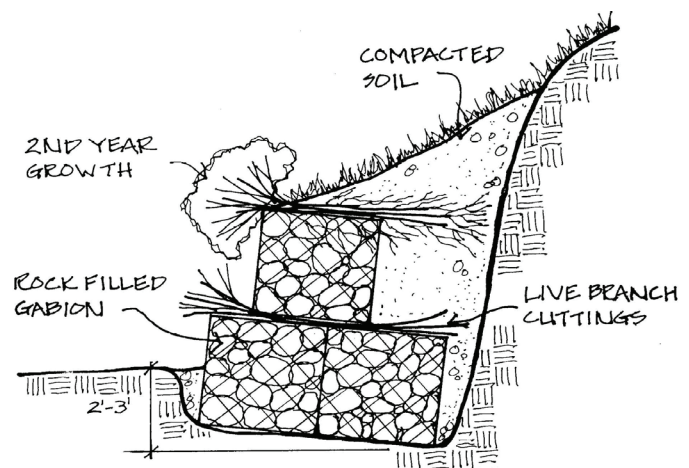

VEGETATED GABION

Vegetated Rock Wall

A combination of rocks and live branches, as used in retaining walls along a slope. Use at the base of a slope where a low wall, not higher 5 feet, is required.

- Provide a well-drained base for the wall.
- Excavate a minimum amount of slope behind the wall.
- Place rocks with long axis slanting, or battered, inward toward the slope.
- Backfill between each layer of rocks and place live branch cuttings and backfill.
- Cover with soil and compact.

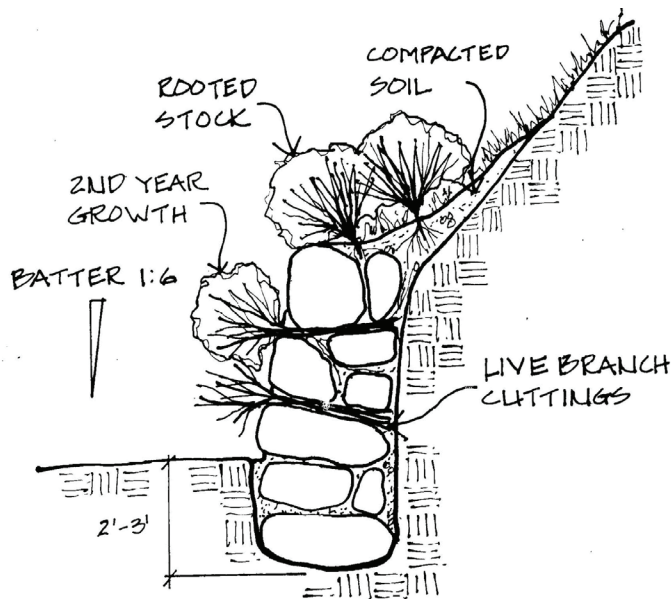

VEGETATED ROCK WALL

Vegetated Riprap/Joint Planting

This technique combines the riprap revetment with the tamping of live stakes between the joints or open spaces in the rocks. Joint planting with riprap increases the stability and the effectiveness of the rock system by forming a living root mat in the base upon which the riprap has been placed. Live stakes must be long enough to extend well into soil below rock surface.

- Roots improve drainage and create a mat that binds and reinforces the soil preventing washouts and loss of fines between and below the rocks.

- When used on stream banks, this method promotes deposition of silts and provides shade that will reduce water temperatures in the stream.

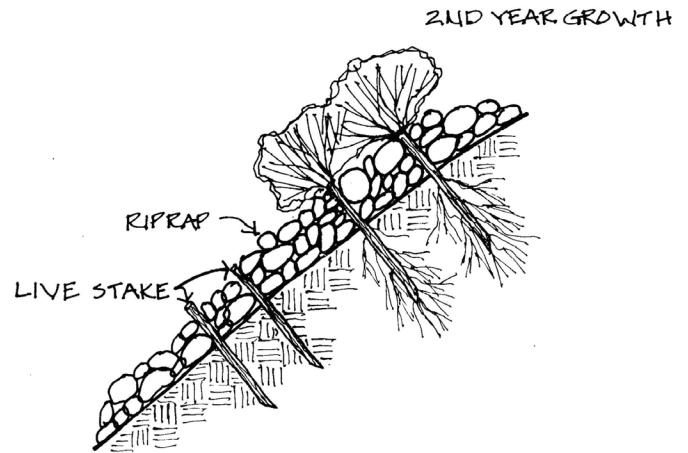

VEGETATED RIPRAP

Geogrids

Geogrids are extremely durable woven materials with a polymer coating that can be used for soil reinforcement. Geogrids have a high tensile strength and are ideal for use on steep slopes and in areas with a narrow right-of-way or where finished slopes will be steeper than 2:1.

- Can be used as an alternative to riprap or a concrete retaining wall.
- Can be planted over with vegetation for additional strength and aesthetics.
- Resist degradation by water and organics found in soils.
- Check with product manufacturer for specific installation details.

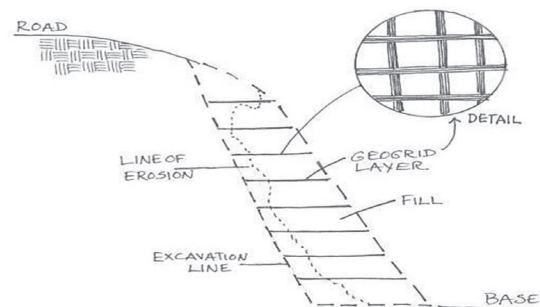

GEOGRID

Erosion Control Mats & Blankets

Mulch mats and blankets are materials that have been formed into sheets of mulch that are more stable than normal mulch. Mats and blankets are used to provide bank stabilization and prevent erosion on a temporary basis on steep slopes. They can also be used in ditches with high water velocities and in other areas prone to erosion. Types of mats and blankets include:

Jute Matting

Jute matting is made from undyed jute yarn, woven into an open 1-inch square weave mesh. It is very effective when placed over seeded and mulched areas to hold soil and seed in place.

- Bury up slope end of each section in a 6-inch vertical slot, and then backfill.
- Overlap each up slope section with 12 inches of mat.
- Overlap side-by-side sections by 4 inches.
- Securely anchor mat with stakes, staples, or rocks.

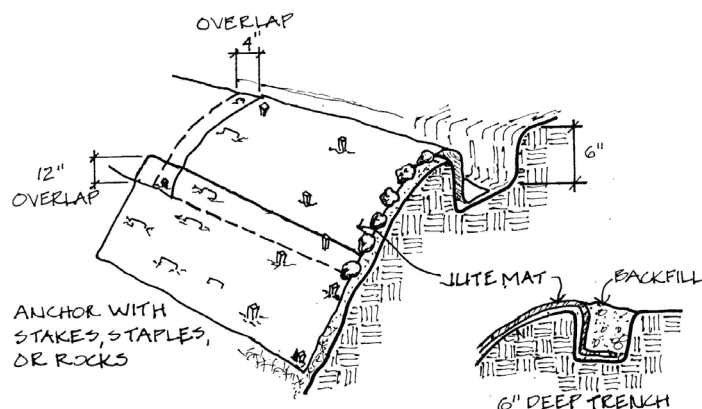

JUTE MATTING

Wood Excelsior Blankets

These blankets are machine-produced mats of 6-inch long curled wood excelsior interwoven with a photodegradable plastic mesh. There is no need to mulch when using a wood excelsior blanket.

- Ends of section should be tightly butted but not overlapped.
- Installation is otherwise similar to jute mat.

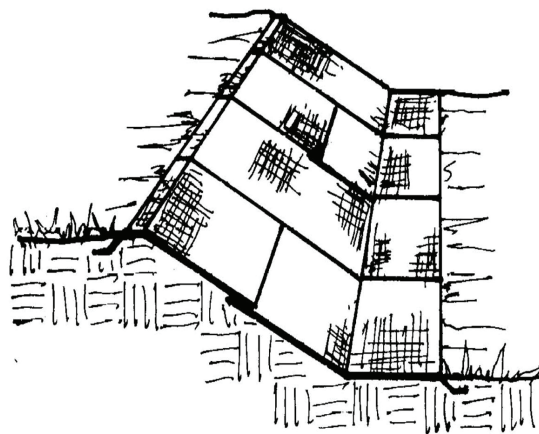

SLOPE INSTALLATION

Mulch Blankets

Mulch blankets are typically straw, coconut, or wood fibers sandwiched between photodegradable plastic. They are used in areas where it is difficult to hold mulch in place and there is erosion potential until vegetation is established.

- Place after area has been seeded.
- Place lengthwise along direction of the slope and secure with staples.

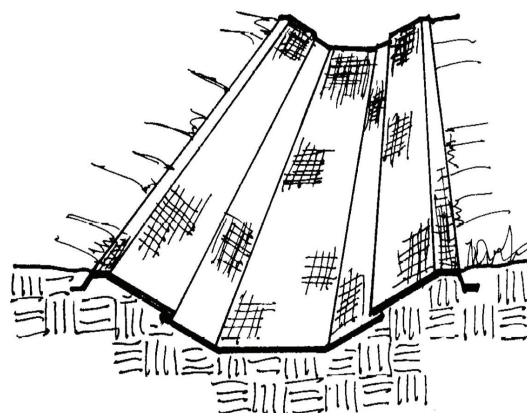

DITCH INSTALLATION

MATting INSTALLATION

ADDITIONAL TECHNIQUES

Buffer Zones

Undisturbed vegetated areas that separate roads, development, or construction sites from sensitive areas such as streams, wetlands and lakes.

Roughness of the vegetation slows stormwater flow and reduces its erosive potential.

Vegetation acts as a natural filter by intercepting sediments, nutrients and other pollutants that may be in storm water.

- May require minimal maintenance.
- Preferred method of slowing and filtering storm water before it enters surface waters.
- Buffer zones are not intended and should not be used for treatment of channelized flow.
- Provides shade and habitat for wildlife.
- Can help stabilize banks and absorb floodwaters.

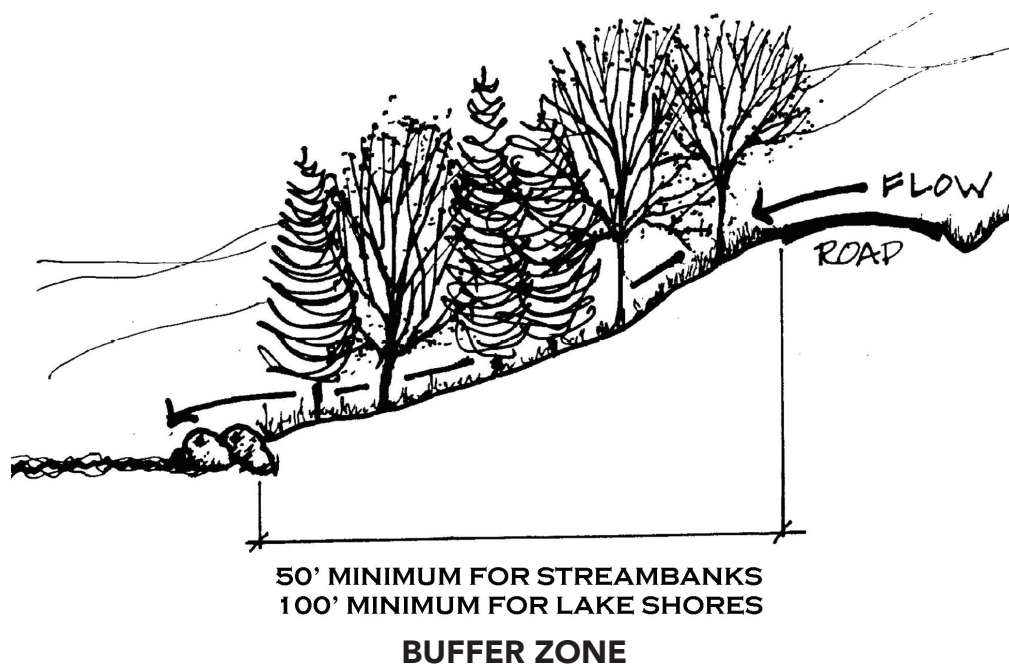

Storage & Borrow Areas

In these areas, soil is stockpiled for future use in road construction or maintenance. Develop an erosion and sediment control plan for the specific site, including:

- Diversion or containment of stormwater runoff from exposed slopes.
- Leave only areas in active use unvegetated.
- Stabilize the exposed areas immediately after use.
- Locate storage areas on the uphill side of a disturbed area so they can act as a diversion for runoff.
- Locate potential areas away from surface waters.
- Control stormwater flowing from storage and borrow areas with previously described temporary control techniques.

Level Spreader

Bermed trench used to intercept and discharge water flow over a wide linear area.

- Prevent gullies by discharging over a wide linear area.
- Generally used at the toe of a slope.
- Construct a long, level bermed trench. Water will discharge evenly over the berm when trench is full.

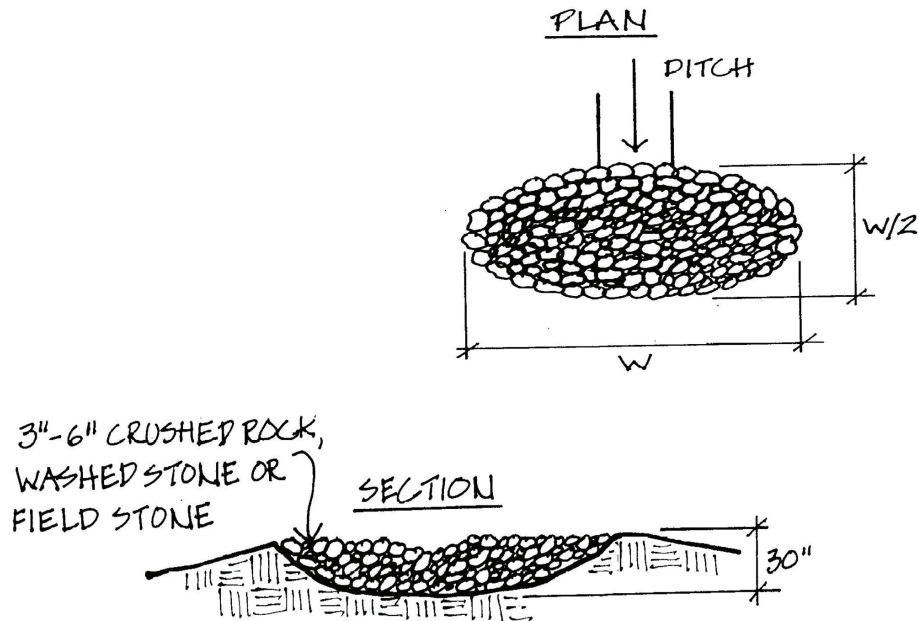

LEVEL SPREADER

Waterbar

Berm or open culvert constructed across a road or driveway used to divert water flowing down the road.

- Use only on very low traffic volume, steep gravel roads.
- Prevents gullies and road washouts.
- Eliminates concentrated sediment deposits.
- Construct low enough for traffic to pass over and angle at approximately 30° across road (not perpendicular).
- Spacing of waterbars is dependent upon road slope.
- Need to be maintained and/or rebuilt periodically.
- Inexpensive means for controlling and diverting water.

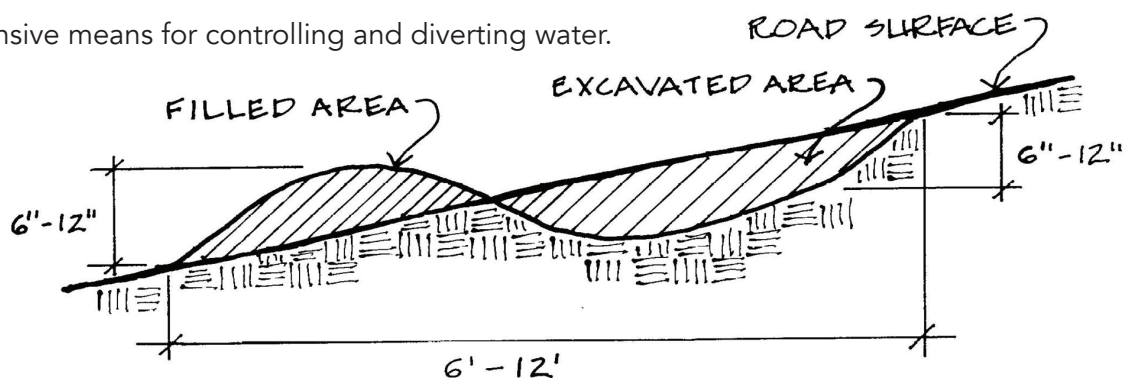

WATERBAR CROSS-SECTION

Climate Impact and Importance of Safe Roads

There are important safety and transportation considerations for the rural roads of the Champlain Watershed of New York. These involve the long periods during the year that ice and snow conditions impact our region, along with the volume of snow and ice that accumulates. These conditions create a number challenges to crews working to maintain the safety and quality of transportation on rural roads.

Typical Challenges

- Salting and deicing.
- Disposal of snow.
- Road conditions -- frost heaves.
- Storage and management of deicing materials.
- Blowing snow across roadways.

Factors influencing the level of service provided

- Treatment cycle time.
- Available deicing materials and how they are used.
- Strategies and tactics.
- Road and weather conditions.

For comprehensive information on Snow and Ice Control consult Cornell Local Roads Program "Snow and Ice Control 2014 Workbook"
http://www.clrp.cornell.edu/workshops/manuals/snow_and_ice_control.pdf

Salting and Deicing

Salt and sand have traditionally been perceived as the cheapest and most effective materials for deicing rural road surfaces. However, they have hidden negative environmental impacts that can outweigh their overall effectiveness.

Salt and other deicing agents, applied even in small quantities, can:

- Deplete the oxygen supply needed by aquatic animals and plants.
- Leach into the ground and change soil

Importance to Water Quality

Among the greatest manmade threats to the water quality of the Champlain Watershed are applications of sand and de-icing solutions needed for road safety during winter situations. These materials leach into the soil, which runoff carries into waters.

composition, making it hard for plants to survive.

- Contaminate groundwater and surface waters.
- Deteriorate paved surfaces, buildings, infrastructures, and the environment.

Sand also has potential negative impacts that can:

- Smother the aquatic life, fill in habitats, and cloud the water.
- Cause premature deterioration of floor surfaces as it is tracked into buildings.
- Lose its effectiveness after becoming embedded in snow and ice.
- Enter catch basins, storm drains, and surface waters if it is not swept up each spring.
- Contribute to clogged storm drains, which can cause flooding.

Overview of Deicing Agents

Numerous common deicing agents that are used on rural roads in the Lake Champlain Watershed of New York include: sodium chloride (rock salt), calcium chloride, magnesium chloride, potassium chloride, sodium or potassium acetate, and calcium magnesium acetate.

Generally, all chemical deicing agents work in the same way. They depress the freezing point of snow and ice and turn the mixture into a liquid or semi-liquid slush. Solid chemical salts bore through ice or snow and form a strong brine solution. This brine spreads under the ice or hard-packed snow and undercuts, breaking the bond to the surface. The detached ice or snow is then more easily removed by mechanical means.

Determining which product to use depends upon the situation. It is a balancing act of performance and cost against adverse consequences. A low cost deicer might do a great job of keeping a walkway open, but it also might kill all of the adjacent vegetation, increase metal corrosion, be tracked in the building and ruin the floors, and be harmful to pets. The first measure of an ice melter's effectiveness is the range of temperatures in which it can provide deicing action within 15 to 20 minutes of application.

Performance and Drawbacks of Deicing Agents

Sodium Chloride, also known as rock salt,

- Provides economical performance at temperatures at, or just below 32°F.
- Loses most of its effectiveness when temperatures fall below 22°F.
- Corrosive to structural steel in bridges and cars.
- Harmful to roadside vegetation.
- Can contaminate surface water and drinking water supplies.

Calcium Chloride

- Costs about 3 times more than rock salt.
- Less corrosive to metals.
- Less harmful to roadside vegetation.
- Most effective compound at low temperatures.
- Leaves a white residue on surfaces when it dries.

Magnesium Chloride

- Costs about 2 times more than rock salt.
- Effective at lower temperatures.
- Less corrosive to metals.
- Less harmful to roadside vegetation.
- Leaves a white residue on surfaces when it dries.

Potassium Chloride

- Costs about 10 times more than rock salt.

- Effective at lower temperatures.
- Less corrosive to metals.
- Considered more environmentally friendly than other salts because of its lower chloride content.

Sodium or Potassium Acetate (contain no chloride)

- Costs about 8 times more than rock salt.
- Effective at lower temperatures.
- Not corrosive to metals.
- Safer for the environment.

Calcium Magnesium Acetate

- Costs about 5 times more than rock salt.
- Effective at lower temperatures.
- Not corrosive to metals.
- One of the most environmentally friendly ice melting compounds.

Best Practices for Disposal of Snow

There are often environmental impacts of the relocating snow that is removed from streets and parking lots. Contaminants are often in the snow from highways and parking lots. These include:

- Animal wastes.
- Dissolved salts.
- Dust, dirt and airborne pollutants.
- Heavy metals.
- Oil.
- Organic and other toxic chemicals.
- Phosphates and other nutrients.
- Suspended solids (sand and similar).
- Trash.

A snow dump area should have good drainage and must be able to handle the effects of the trucks and loaders using the site in the winter and early spring. Poor soils under the dumpsite will result in a potential mess in the spring when you try to clean up all the debris left behind.

There are also NYSDEC, APA, and local regulations that must be addressed.

Location, Design, and Operational BMPS for Snow Dumps

Avoid the following locations to minimize environmental impact:

- Landfills.
- Agricultural land.
- Areas containing sensitive vegetation.
- Wetlands and floodplains.
- "High water" locations adjacent to water bodies.
- Areas having steep slopes and erodible soils.
- Areas over fractured or folded (non horizontal layers) bedrock that is near the surface.
- Areas that could contaminate an aquifer being used for drinking water.
- Areas having above-ground or below-ground utilities.
- Areas close to residential housing (noise and aesthetic considerations).
- Areas that may impact combined storm water/ sewage systems.
- Recreational areas.
- Direct dumping into a water body.
- Direct dumping into or over existing drainage features (catch basins, ditches, swales, etc.).

Potential acceptable dump sites:

- Seasonal gravel parking lots.
- Undeveloped or abandoned industrial sites.

Design considerations for snow dump sites:

- Sufficient size to accommodate winters with heavy snows.
- Cost analysis of haul distances.
- Adequate access, egress, site mobility and signage.
- Features to prevent groundwater

contamination.

- Features to properly contain, channel and discharge meltwater.
- Consideration of downstream discharge impacts.
- Proper grading.
- Silt fence or other barriers.
- Vegetation buffer strip (downstream).
- Aesthetic considerations (berms, plantings, etc.).
- Ease of collection and the storage of debris.
- Are there maintenance areas (equipment, fuel, utilities, office, etc.).
- Necessary permits, zoning allowances, etc.

Operational considerations for snow dump best management practices:

- Environmental monitoring procedures and stations.
- Record keeping and accounting procedures.
- Off-season maintenance provisions.
- Decommissioning procedures (as necessary).
- Security.

Deicing Agents

Deicing agents may be portable or permanent. Snow is dumped or pushed into these devices that contain a large heat source. The resulting meltwater typically goes into a stormwater discharge system. There are fairly easy procedures and techniques available for removing trash and solids from the meltwater. Although the energy demand from the fuel can be quite costly, deicing agents may be more cost-effective than hauling.

The first step in deciding if deicing agents are a viable alternative to hauling and disposing of snow in snow dumps is a life-cycle cost analysis. The production rate, equipment purchase price, service life, salvage value, maintenance costs and energy costs of a snow melting system are compared to the production rate and costs associated with hauling and the snow dump.

For comprehensive information on deicing agents consult the Salt Institute's

Snowfighters Handbook

700 North Fairfax Street, Suite 600
 Alexandria, Virginia 22314-2040
 Telephone: (703) 549-4648
 Fax: (703) 548-2194
 Website: <http://www.saltinstitute.org>
 Email: info@saltinstitute.org

ROAD CONDITIONS

**Snow & Wind Management –
 Living Snow Fences**

Snowdrifts can be a major problem for roadways. In areas of high winds and blowing snow across roadways, living snow fences are a BMP for snow and ice control that can provide a number of benefits. Living snow fences are trees, shrubs and native grasses strategically planted along roads and farm fields. These live barriers, using appropriate local types of vegetation, trap snow as it blows across fields, piling it up before it reaches a road, waterway, or farmstead. Snow fences can:

- Prevent big snow drifts that lead to stranded motorists.
- Improve driver visibility and reduce vehicle accidents.
- Reduce use of public money by reducing plow time.
- Lessen impact on the environment with less salt use, fewer truck trips and less fuel consumption.
- Control soil erosion and reduce spring flooding.
- Serve as visual clues to help drivers find their way.

For detailed information on Living Snow Fences consult the SUNY ESF Living Snow Fences website at: <http://www.esf.edu/willow/lsf/>

Frost Heaves

Frost heaves are a major problem in climates that have a freeze/thaw season. In New York State this period usually occurs anytime from February 15 to April 1, but sometimes a January thaw will cause frost heave damage to pavement surfaces. As ice forms in wet soil the expansion and contraction can damage the roadway and culverts and heave occurs when these three conditions are present:

- Freezing temperatures.
- Frost susceptible soil.
- Water in the soil.

Frost heaves cause flexural stress and formation of bending cracks that eventually need to be sealed. To prevent frost damage, one of these three conditions must be eliminated, and since we cannot control the weather, we have to either replace the soil or eliminate the water. Water can rise through soil by capillary action. For some soils the height of rise can be considerable, depending on the soil particle size. The smaller the particle the higher the water will rise from the water table, much the same way kerosene rises in the wick of a lamp.

Travel Corridor Stewardship

Latticed with world-renown scenery and landmarks, wild forests and wetland, the Champlain Watershed of New York contains a variety of unique, endangered or threatened plants, and ecologically sensitive habitats.

As historic towns, quaint villages, and quiet hamlets endure the test of time, the region continues to be adorned with incredible geographic, historic, and cultural resources that need to be protected. Throughout these areas, the potential for the detrimental effects by road projects must be assessed, adequately planned for and harmonized with the fragile surrounding ecosystem.

WILDLIFE FRIENDLY RURAL ROADS BMPS

Many of the rural roads in the New York Champlain Basin are within the lands of the Adirondack Park, where wildlife habitats receive special protections. Travel corridors can severely impact habitat, causing both loss and fragmentation. These impacts are two of the most significant threats to wildlife throughout the Lake Champlain Basin.

Travel corridors can result in habitat fragmentation through the division of large, contiguous areas into small, isolated sections that isolate individuals. Once forced into containment these reduced populations lose genetic vitality and are at high risk of local extinction, particularly from migratory collisions with vehicles.

In addition to the harmful effects on habitats, travel corridors create noise and low frequency vibrations that can interfere with ability of native wildlife to communicate, detect prey, and avoid predators. Travel corridors also increase the ability of invasive species to rapidly mobilize.

Despite the many benefits, erosion control methods also have the potential to significantly disturb habitats. Wildlife can become entangled in plastic netting and other synthetic materials used for erosion control, increasing potential of mortalities. The use of synthetic materials, such as geotextiles/silt fences for erosion control, continues to be utilized on many sites, often without consideration for potential impact on wildlife, when abandoned.

The following are a few key wildlife considerations for project planning:

- Consult with local natural resource agencies (SWCD, DEC, APA, Ausable River Association, Boquet River Association, Cornell Cooperative Extension, Nature Conservancy, USFWS, Lake George Association, etc.) before starting a project. They can help you identify sensitive areas, habitats, and endangered or protected species.
- When erosion control is necessary, select products, preferably with biodegradable netting. (Consider the use of erosion-control materials that are wildlife friendly, and available through erosion control product suppliers: natural fiber, biodegradable polyesters, etc.).
- Avoid the use of products that require UV-light to biodegrade (also called “photodegradable”), as they do not degrade properly when shaded by vegetation.
- Utilize netting with rectangular-shaped mesh (not square mesh).
- Utilize netting with flexible (non-welded) mesh.
- Utilize native plant species for erosion control practices.

Beavers

Beavers play a particularly important role in the Lake Champlain Basin’s natural landscape by creating pond and wetland habitat. However, beavers create problems for road crews by constructing dams that frequently block culverts and impound water that can be released creating downstream destruction and massive economic losses during periods of heavy precipitation.

The following are best management practices developed to protect roadways from beaver-related infrastructure damage.

Beaver Baffle. A baffle system is a drain for the dam itself, creating an outlet for water straight through the dam. It requires only shallow digging into the dam. There are several versions of this involving perforated pipe intakes and inserting the discharge pipe through the dam.

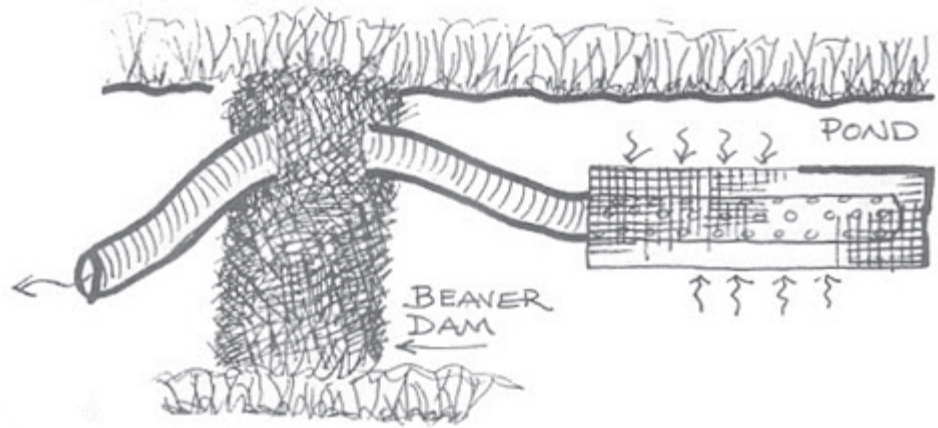

"Beaver Reliever" Designed by the US Forest Service, this installation features additional perforated pipes parallel to the culvert. These extra perforated pipes help maintain the water level in the pond below the level of a culvert.

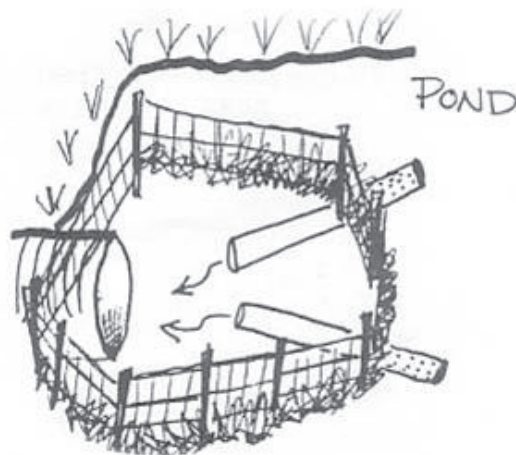
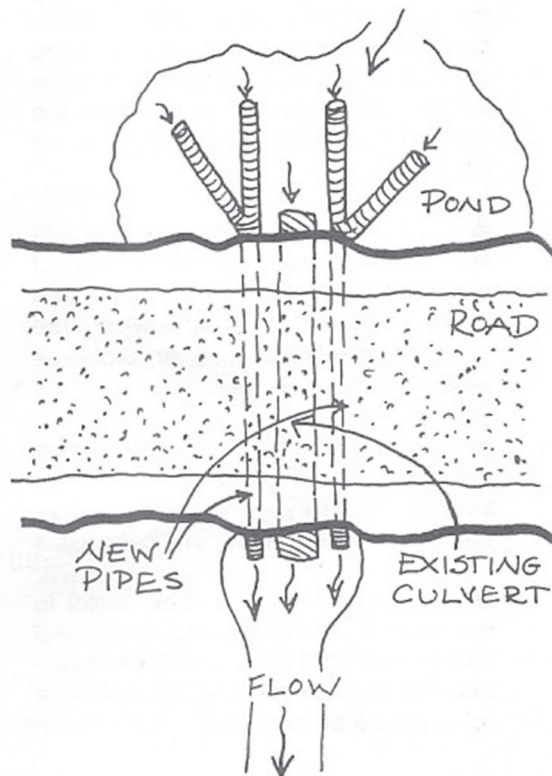

The damming of a culvert is the easiest way for beavers to create habitat. Inevitably, this results in recurring maintenance problems and time vacuums for road crews, since beavers tend to be stubborn for relocating on their own and reconstruct dams in the same locations.

In recent years, additional creative solutions and methods have been developed to cope with the beavers as alternatives to dismantling dams or extermination. These options include:

- Live in harmony and evaluate the real threat to the road and downstream infrastructure. A "live and let live" approach would be most effective.
- Attach a 36" x 36" white flag to two poles near the culvert when beavers begin to construct a new dam. The color and motion may create a "scarecrow" effect, discouraging dam building.
- Weld an elbow onto the culvert to make it harder for the inlet orifice to be plugged.
- A 90-degree angle of the culvert pointing downward below water level results in continual drainage, and the beavers won't be able to plug the inverted culvert end.

Note: If a dam needs to be dismantled, avoid sudden destruction of the dam. The resulting release of water and accumulated sediment from behind the dam can cause massive turbidity and flooding problems downstream and may result in a violation of NYS DEC Water Quality Standards. If a dam must be removed, do so gradually. Permits may be required for dismantling a dam. Contact your County SWCD for assistance.

VEGETATION MANAGEMENT

Natural, native vegetation lining the road corridors throughout the Lake Champlain Watershed of New York is an important, intrinsic natural resource to both residents and visitors. Roadside vegetation is critical for soil stabilization through extensive root systems, while providing shade in the summer, living snow fences in winter, and beautiful foliage in the fall.

Native roadside trees have shown to have a traffic "calming" effect, slowing motorists and instilling a greater sense of community pride throughout

the watershed. Trees growing along road corridors are undoubtedly exposed to many more stresses than forested trees. Root and trunk injuries are common during ditch work, plowing, and grading. Furthermore, roadside trees have an increased exposure to salt from winter road maintenance, increasing mortalities to the lesser salt tolerant species. Highway maintenance crews should achieve a balance between road maintenance and vegetation protection throughout the watershed's rural roads.

Please Note: The Adirondack Park Agency enforces regulations about roadside tree management within the Park. Please contact the Adirondack Park Agency before undertaking roadside tree removal along road segments.

Roadside Tree Pruning Considerations

When in doubt about tree pruning or removal, please consult a DEC Forester and/or local arborists to identify and remove hazardous trees.

- Avoid grading and ground disturbance near tree trunks and under tree canopies if possible, to prevent damaging root systems.
- Roots that are exposed during grading or excavating should be cut cleanly to promote quick wound closure and covered with soil, mulch or burlap as soon as possible.
- If possible, prune trees during dormancy. When pruning limbs, do not leave a stub or cut limbs flush with the stem, trim to the branch collar.
- Do not prune trees with a flail mower or boom arm mower.
- In heavily wooded areas, consider thinning the roadside trees by selecting the best trees to retain, and cutting competing trees (Obtain APA permit within the Park*).
- Replant areas where the trees have been removed for construction purposes.

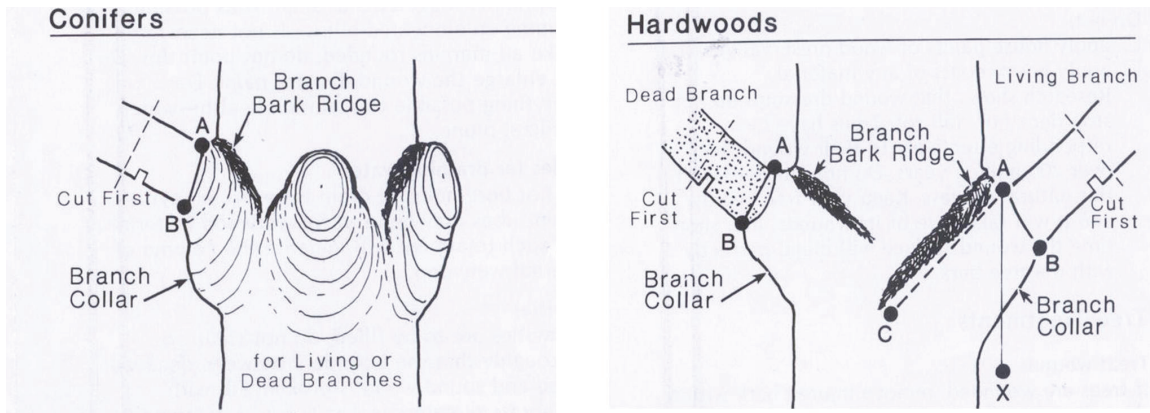

Vegetation Management - Prune limb along the A-B line

From: Shigo, Alex L. 1984. Homeowners guide for beautiful, safe, and healthy trees. USDA Forest Service NE-INF-58-84.

Aesthetics

Road corridor maintenance has a tendency to appear unsightly and destructive to residents and visitors. By performing low impact maintenance and practicing good erosion and sediment control techniques during and after the construction, negative visual perceptions can be alleviated. As a result, an increase of public support for the RRAMP program can be achieved through proper road corridor maintenance.

For additional information and questions regarding roadside trees and vegetation, please contact the Adirondack Park Agency, the New York State Department of Environmental Conservation, and/or the Adirondack Park Invasive Plant Program (APIPP).

STEWARDSHIP OF INTRINSIC CULTURAL & REGIONAL RESOURCES

Work Conducted on or Adjacent to Cultural Resources

Cultural resources throughout the Lake Champlain watershed include a variety of historic properties, at least fifty years old that meet the criteria for listing on the National Register of Historic Places. Historic property types include:

- *Building* - Constructed for human activity (house, school, church). The historic property may include the historic building and associated landscape features within a designed or legally defined parcel of land.
- *Structure* - Functional construction for purpose other than human shelter (bridge, culvert, barn, dam, earthworks).
- *Object* - Primarily artistic in nature, small in scale or simply constructed (mile markers, historic markers, signs, fountains, statuary, sculpture). Although objects may be moveable, they are associated with a specific setting or environment.
- *Site* - Location of a significant event, a prehistoric or historic occupation or activity,

or a building or structure, which may be standing, ruined, or vanished (battlefield, cemetery site, mill site, prehistoric village). Archaeological sites often are not marked by physical remains visible on the ground surface.

- *District* - A concentration of buildings, structures, objects, and/or sites united by plan or physical development. The relationship of buildings to each other, setbacks, fence patterns, views, driveways and walkways, and street trees together may contribute to the historic significance of a district.
- *Parkways* - New York State has many historic parkways, eligible for or listed in the National Register of Historic Places.
- *Canals* - The New York State Canal System has been determined eligible for listing on the National Register.

Road Corridor maintenance activities have the potential to affect cultural resources when they involve ground disturbance in previously undisturbed soils; repair, removal, replacement or relocation of objects within the right-of-way; or

work on or adjacent to culverts and streams. These types of activities may be subject to compliance with Federal and State historic preservation

Examples of maintenance activities that may affect cultural resources include but are not limited to:

- Slope stabilization.
- Shoulder & pavement widening.
- Repair or relocation of retaining walls.
- Scour protection.
- Dredging.
- Work to drainage channels and ditches.
- Replacing or extending culverts.
- Waste material and staging area sites.
- Earthwork occurring in undisturbed soils.
- Mature tree or vegetation removal (grubbing).
- Repair, restoration or removal of sidewalks, lights, guide rails, signs, fences or stone walls.
- Cut and fill activities.

Maintenance activities have the potential to affect the setting or landscape elements associated with historic properties. The setting as a whole, or individual components, may contribute to the significance of historic properties. Examples include:

- Fences.
- Walls.
- Sidewalks.
- Mature Trees.
- Light Posts.
- Historic structures or objects (the Regional NY SHPO should be contacted when repair of structures is necessary).

Recommended Treatments at Historic Properties

Work on or adjacent to historic properties should strive to retain and preserve the historic character that contributes to the significance of the resource. In general, the likelihood of impacting historic properties can be minimized by the following practices:

- Erosion prevention.
- Protection of fragile soils, slopes and land forms.
- Limits on encroachment by vehicles and equipment.
- Limits on grading, cut and fill.
- Limits on removal of mature trees or vegetation associated with designed landscapes, unless the tree or trees are hazardous or pose sight distance concerns.

Routine Maintenance for Historic Bridges

Maintenance work on bridges and culverts built after 1961 do not require review unless these activities will disturb the adjacent ground or stream bank. For highway bridges built prior to 1961, contact SHPO to determine if the bridge is historic. Preventative or routine maintenance activities on historic bridges are generally exempt from further review.

Routine bridge maintenance and repair actions include:

- Repair or replacement of bridge decking and bridge expansion joints with the same or similar materials.
- Cleaning drainage conveyances; Modifications of expansion joints.
- Maintenance and repair of pedestrian railing when the existing rail is a contributing element.
- Maintenance of bridge bearings, including lubrication.
- Repair or replacement of steel beam plates and/or bridge bearings with the same or similar materials.
- Repair of cracks in superstructure and substructure with the same or similar materials.
- Replacement of steel caps, protective jackets, and dolphins.
- Repairs to abutments using the same or similar materials, where no excavation is proposed.
- Replacement of truss members using new members of the same size, profile, and appearance as the original members. The

method for attaching the new members will retain the appearance of the original attachment system (e.g., rivets may be replaced with button-headed or dome-headed bolts).

- Repainting of metal structure or components of either superstructure or substructure to match existing color.
- Tightening of loose diagonals and lateral bracing on metal truss bridges.
- Pressure washing and cleaning of structure. Removal of debris from channels around piers and abutments.
- Repair of damage to substructure due to scour.

For historic bridges, replacement of structural members or repairs, other than those listed above may require review by NYS Historic Preservation Office and/or NYS DOT.

Discovery of Cultural Resources or Human Remains

In the event that potential grave sites, buried walls, or suspected artifacts are encountered during maintenance/construction of road corridor activities, suspend work immediately, protect the location from further disturbance, and contact the New York State Historic Preservation Office (SHPO) at (315) 482-2593 or (518) 584-2000.

IMPORTANT RESOURCES FOR STEWARDSHIP BEST MANAGEMENT PRACTICES

For comprehensive guidance on Best Management Practices for stewardship of the Basin's (as well as New York State's) special resources:

New York State Department of Transportation

NYS DOT Environmental Handbook for Transportation Operations

A Summary of the Environmental Requirements and Best Practices for Maintaining and Constructing Highways and Transportation Systems, June 2011

NYS DOT Environmental and Cultural Resources, 2011

<https://www.dot.ny.gov/divisions/engineering/environmental-analysis/repository/oprhbook.pdf>

New York State Adirondack Park Agency Park Policy and Planning Division

P.O. Box 99
Ray Brook, NY 12977
518-891-4050
<http://www.apa.gov>

Wildlife Conservation Society Adirondack Communities and Conservation Program Wildlife Conservation Society

132 Bloomingdale Avenue, Suite 2,
Saranac Lake, NY, 12983 USA
(518) 891-8872
accp@wcs.org

PROTECTING WILDLIFE CONNECTIVITY THROUGH LAND USE PLANNING:

Best Management Practices and the Role of Conservation Development

Wildlife Conservation Society

Adirondack Program Technical Paper No. 4

Zoë P. Smith, Michale J. Glennon,

Leslie N. Karasin, Sarah E. Reed,

and Heidi E. Kretser

December 2012

Rural Roads Active Management Program

A model of local and regional collaboration and cooperation

The rural areas throughout the Lake Champlain Watershed of New York require innovative, effective best management practice planning and subsequent implementation for long term, sustainable protection of roadways from erosion and degradation of infrastructure. Recognizing this concern, numerous members and partner organizations within the boundaries of the watershed, and beyond, forge tremendous momentum towards overcoming the ecological and economic challenges facing the protection of Lake Champlain. The extensive, collaborative efforts of these entities will ensure the vitality of Lake Champlain and its watershed well into the future.

County Soil & Water Conservation Districts Contact Information

Statewide: http://www.nys-soilandwater.org/contacts/county_offices.html

New York Lake Champlain Basin Counties

<p>SERVICES PROVIDED</p> <ul style="list-style-type: none"> ○ Hydroseeding/Soil Stabilization supplies and equipment ○ NYS DEC General Permit ○ Technical Assistance on Erosion and Sediment Control / Stormwater ○ Technical Assistance on Culvert Sizing and Installation ○ Grant assistance and Development ○ Wetland Maps ○ Aerial Mapping ○ Stream Geomorphology Assistance 	<p>Clinton County</p> <p>6064 Route 22, Suite 1 Plattsburgh, NY 12901 Phone (518) 561-4616 ext. 3 Fax: (518) 563-5211 Email: nate.grue@ny.nacdnet.net</p>
<p>Essex County</p> <p>Cornell Cooperative Extension Center 3 Sisco Street Westport, NY 12993 Phone: (518) 962-8225 Fax: (518) 962.4002 E-mail: essexswcd@westelcom.com Web: http://www.essexcountyswcd.org/</p>	<p>Franklin County</p> <p>151 Finney Blvd Malone, NY 12953-9622 Phone (518) 483-4061 ext. 5 Fax: (518) 483-1682 E-mail: fcswcd@fcswcd.org Web: http://fcswcd.org</p>
<p>Warren County</p> <p>394 Schroon River Road Warrensburg, NY 12885 Phone: (518) 623-3119 Fax: (518) 623-3519 E-mail: jim99@nycap.rr.com Web: www.warrenswcd.org</p>	<p>Washington County</p> <p>USDA Service Center 2530 State Route 40 Greenwich, NY 12834-9627 Phone: (518) 692-9940 ext. 3 Fax: (518) 962-9942 E-mail: lori.sheehan@ny.nacdnet.net</p>

Local & Regional Organizations			
Organization	Services Provided	Location(s)	Contact #
Adirondack Park Agency	<ul style="list-style-type: none"> ○ Wetland Regulatory Information ○ Land Use Information within the Adirondack Park ○ Regulations and Permits ○ Roadside Vegetation Maintenance in Park 	Ray Brook, NY	(518) 891-4050
Adirondack Park Invasive Plant Program (APIPP)	<ul style="list-style-type: none"> ○ Native Plant information ○ Invasive Plant Maintenance and Removal ○ Plant Identification and Education 	PO Box 65 Keene Valley, NY 12943	(518) 576-2082 www.adkinvasives.com
Ausable River Association (AsRA)	<ul style="list-style-type: none"> ○ Culvert Replacement / Stream Crossing Educational Guidance ○ Grant Assistance and Development 	Wilmington, NY	(518) 637-6859
Boquet River Association (Brass)	<ul style="list-style-type: none"> ○ Culvert Replacement / Stream Crossing Educational Guidance ○ Grant Assistance and Development 	Willsboro, NY	info@boquetriver.org
Champlain Watershed Improvement Coalition of New York (CWICNY)	<ul style="list-style-type: none"> ○ Incorporates public sector/private citizen partnerships to implement water quality for the Lake Champlain watershed of NY. 	3 Sisco Street Westport, NY 12993 Phone: (518) 962-8225 Fax: (518) 962.4002	Phone: (518) 962-8225 Fax: (518) 962.4002
Cornell Cooperative Extension Offices	<ul style="list-style-type: none"> ○ Pest / Invasive Species Management ○ Pesticide/Herbicide Education and Information ○ Grant Assistance and Development 	Clinton County	(518) 561-7450
		Essex County	(518) 962-4810
		Franklin County	(518) 483-7403
		Warren County	(518) 623-3291
		Washington County	(518) 746-2560

Local & Regional Organizations			
Organization	Services Provided	Location(s)	Contact #
Cornell Local Roads Program	<ul style="list-style-type: none"> ○ Roadway Erosion and Drainage ○ Technical and Education Assistance ○ Stormwater Technical and Educational Expertise 	416 Riley Robb Hall Ithaca, NY 14853	(607) 255-8033 www.clrp.cornell.edu/
Lake Champlain-Lake George Regional Planning Board	<ul style="list-style-type: none"> ○ Grant assistance and Development ○ Stormwater Education and Information 	PO Box 765 Lake George, NY	(518) 668-5773
Lake George Association (LGA)	<ul style="list-style-type: none"> ○ Education Assistance ○ Native Plant information ○ Green infrastructure guidance ○ Lake friendly living assistance 	2392 Rte. 9 Lake George NY 12845	(518) 668-3558
Nature Conservancy – Adirondack Chapter	<ul style="list-style-type: none"> ○ Culvert Replacement ○ Stream Crossing Educational Guidance ○ Grant Assistance and Development 	PO Box 65 Keene Valley, NY 12943	(518) 576-2082
NYS DEC – Region 5	<ul style="list-style-type: none"> ○ Stormwater and Construction ○ Site Permit Information ○ State Regulatory Information 	Ray Brook, NY	(518) 897-1200
		Warrensburg, NY	(518) 623-1200
New York State Department of Health	<ul style="list-style-type: none"> ○ Public Water Supply Identification and Protection ○ Tick Identification information 	Saranac Lake, NY	(518) 891-1800
		Glens Falls, NY	(518) 793-3893
NYS DOT Region 1	<ul style="list-style-type: none"> ○ Legal Information ○ NYS Transportation Policies ○ Infrastructure Engineering/ Planning Information ○ NYS Drainage Law 	Albany, NY	(518) 474-6178

Local & Regional Organizations			
Organization	Services Provided	Location(s)	Contact #
NYS Historic Preservation (SHPO)	<ul style="list-style-type: none"> ○ Site Evaluation Assistance ○ Assistance with protection of cultural and historic resources throughout the Lake Champlain Region 	PO Box 189 Waterford, NY 12188	(518) 237-8643
NYS Office of General Services – Property Acquisition	<ul style="list-style-type: none"> ○ Procurement of Equipment ○ Availability of Surplus Equipment ○ Land Management/ Easement Information 	41st Floor, Corning Tower Empire State Plaza Albany, NY 12242	(518) 474-3899

Emergency Contacts		
COUNTY EMERGENCY SERVICES DEPARTMENTS	Clinton County	(518) 565-4791
	Essex County	(518) 873-3900
	Franklin County	(518) 483-8584
	Warren County	(518) 761-6490
	Washington County	(518) 747-7520
DIG SAFELY	East Syracuse, NY	811 or (800) 962-7962
ENVIRONMENTAL PROTECTION AGENCY	New York, NY	(800)-424-8802
FEDERAL EMERGENCY MANAGEMENT AGENCY FEMA - Region 2	New York, NY	(212) 680-3600
NYS DEC FLOOD PROTECTION AND DAM SAFETY	Albany, NY	(518) 401-8185
NYS DEC SPILLS	Ray Brook, NY	(518) 897-1242
	Warrensburg, NY	(518) 623-1238
US ARMY CORPS OF ENGINEERS	Watervliet, NY	(518) 266-6360
US FISH AND WILDLIFE SERVICE	Cortland, NY	(607) 753-9334

Additional Information Resources		
American Association of State Highway and Transportation Officials	444 N. Capital Street, NW (Suite 225) Washington, DC 20001	(202) 624-5800
American Public Works Association	1275 K Street, NW, Suite 750 Washington, DC 20005	(816) 472-6100
American Road and Transportation Builders Association	1010 Massachusetts Ave, NW Washington, DC 20001	(202) 289-4434
NYS Association of Towns	146 State Street Albany, NY 12207	(518) 465-7933
NYS Association of Town Superintendents of Highways, Inc.	4294 Crains Mills Road Truxton, NY 13158	(607) 842-6458
New York State Conference of Mayors and other Municipal Officials	119 Washington Ave Albany, NY 12210	(518) 463-1185
New York State County Highway Superintendents' Association	29 Elk Street, Suite 200 Albany, NY 12207	(518) 465-1694
Vermont Better Backroads Program	617 Comstock Rd., Suite 2 Berlin, VT 05602	(802) 828-4595

Recommended Practices Manual: A Guideline for Maintenance and Service of Unpaved Roads water.epa.gov › Pollution Prevention & Control › Polluted Runoff Recommended Practices Manual: A Guideline for Maintenance and Service of Unpaved Roads. <http://water.epa.gov/polwaste/nps/unpavedroads.cfm>

Rural Roads | Agriculture | US EPA <http://www.epa.gov/oecaagct/trur.html>

Glossary

Aggregate - Any of various loose, particulate materials such as sand, gravel, or pebbles, added to a cementing agent to make concrete, plaster, etc.

Backhoe - A hydraulic excavating machine consisting of a tractor having an attached hinged boom, with a bucket with movable jaws on the end of the boom.

Backfill - The material used to refill a ditch or other excavation, or the process of doing so.

Batter - The angle of the front of a retaining structure with respect to a vertical plane.

Bench - A horizontal surface or a step in a slope that breaks the continuity of the slope.

Berm - A linear mound of earth or other material.

Binder - A substance that holds loose material together.

Brush layering - Live branch cuttings laid in a crisscross fashion on benches between successive lifts of soil.

Channel - A natural stream that conveys water or a ditch excavated for the flow of water.

Coir log - Matting made from the fiber from the husk of a coconut used for erosion control.

Crib Structure - A hollow structure constructed of mutually perpendicular, interlocking beams or elements.

Culvert - Usually a factory assembled round-shaped conduit connected together with couplers or bands; it differs from a bridge in that it is usually constructed entirely below the road surface.

Cutting - A branch or stem pruned from a living plant.

Dead Stout Stake - A 2x4 timber that has been cut into a specific shape and length.

Detention Structure - A basin or pond used in managing stormwater runoff through temporary holding and controlled release of storm water.

Detention Dam - A dam constructed for the purpose of temporary storage of stream flow or surface runoff and for releasing the stored water at controlled rates.

Disk Harrow - An agricultural implement with spike like teeth or upright disks, drawn chiefly over plowed land to level it, break up clods, root up weeds, etc.

Diversion - A channel, often with a supporting berm on the lower side, constructed across or at the bottom of a slope for the purpose of intercepting surface runoff; to minimize erosion; or to prevent excess runoff from flowing onto lower lying areas.

Diversion Dam - A barrier built to divert part or all of the water from a stream into a different course.

Embankment - A structure of soil, aggregate, or rock material constructed above the natural ground surface.

Energy Dissipater - A device used to reduce the energy of flowing water.

Erosion - The wearing away of the land surface by running water, wind, ice or other geological agents, including such processes as gravitational creep; detachment and movement of soil or rock fragments by water, wind, ice or gravity.

Filter Strip - A long vegetative planting area used to retard or collect sediment for the protection of watercourses, diversions, drainage basins, or adjacent properties.

Fish Habitat - Resources and conditions essential for the production of fish including sufficient water quality and quantity, spawning, nursery, rearing and food supply areas - all of which fish depend on directly or indirectly for their processes.

Gabion - A patented woven wire basket filled with rocks of such size that they do not pass through the openings in the basket; individual baskets are stacked in place like building blocks and filled with rock to form erosion resistant structures.

Geotextile - Synthetic polyethylene fibers manufactured in a woven or loose non-woven pattern to form a blanket-like product.

Habitat - The environment in which the life needs of a plant or animal are supplied.

Header/Headwall - Structure built at the inlet or outlet of a culvert to protect the inlet/outlet from erosion.

Hydroseeding - Sowing of seed by distribution in a stream of water, mulch and tackifier propelled through a hose.

Joint Planting - The insertion of live branch cuttings between openings of rocks, blocks, or other inert materials into the natural ground.

Live Cribwall - A hollow, structural wall formed out of mutually perpendicular and interlocking members, usually timber, in which live branch cuttings are inserted through the front face of the wall into the crib fill and/or natural soil behind the wall.

Live Branch Cuttings - Living, freshly cut branches of woody shrub and tree species that propagate from cuttings embedded in the soil.

Live Fascine - Bound, elongated sausage-like bundles of live cut branches that are placed in shallow trenches, partly covered with soil, and staked in place to arrest erosion.

Live Stake - Cuttings from branches that are tamped or inserted into the earth.

Living Snow Fences - Trees, shrubs, grasses strategically planted, trap snow blowing across fields before they reach roads.

Mulch - A natural or artificial layer of plant residue or other materials covering the land surface which conserves moisture, holds soil in place, aids in establishing plant cover, and minimizes temperature fluctuations.

Permeability - The capacity of a porous rock or sediment to permit the flow of fluids through its pore spaces.

Plunge Pool - A depressed area used to dissipate the energy of flowing water that may be constructed or naturally created by flowing water. These pools may be protected by various lining materials.

Pollutant - Dredged soil, solid waste incinerator residue, sewage, garbage, sewage sludge, chemical wastes, biological materials, radioactive materials, heat, wrecked or discarded equipment, rock, sand, cellar dirt and industrial, municipal, and agricultural waste discharged into water.

Retention Structure - A natural or artificial basin that functions similar to a detention structure except that it may maintain a permanent water supply.

Riprap Revetment - Broken rock, cobbles or boulders placed on earth surfaces, such as the face of a dam or the bank of a stream for protection against the action of water.

Road Crown - Convex section or outline of the road surface.

Rock Apron - Erosion protection placed in an area of high velocity flow such as a culvert outlet.

Runoff - The portion of the precipitation on a drainage area that does not infiltrate and is discharged from the area.

Scarify - To abrade, scratch, or modify the surface; for example, to break the surface of a road with a narrow-bladed implement.

Sediment - Solid material, both mineral and organic, that is in suspension, is being transported, or has been moved from its site of origin by air, water, gravity or ice and has come to rest on the earth's surface either above or below sea level.

Sheet Flow - Water, usually storm runoff, flowing in a thin layer over the ground surface.

Slope - The degree of deviation of a surface from horizontal, measured in a numerical ratio, percent, or degrees; expressed as a ratio or percentage, the first number is the horizontal distance (run) and the second number is the vertical distance (rise) as 2:1, 50 percent, or 30 degrees.

Slope Board - A device, usually of wood, created to confirm the cross slope of a road, ditch, or bank.

Soil Bioengineering - Use of live, woody vegetative cuttings to repair slope failures and increase slope stability, often combined with inert structures and materials.

Sub-base - The drainage layer of a road between the surface and the existing ground.

Surface Water - All water the surface of which is exposed to the atmosphere.

Swale - An elongated depression in the land surface that is at least seasonally wet, is usually vegetated, and is normally without flowing water. Swales conduct stormwater into primary drainage channels and provide some groundwater recharge.

Tamp - To force in or down by repeated, rather light, strokes.

Ten-year Frequency Storm - Maximum quantity of water flow per second expected at a particular water crossing, on a statistical average, once every ten years; it has a ten percent probability of occurring in any given year.

Terrace - An embankment or combination of an embankment and channel across a slope to control erosion by diverting or storing surface runoff instead of permitting it to flow uninterrupted down the slope.

Toe of the Slope - Base of the slope.

Underdrain - A drain placed beneath the surface of a road.

Vegetated Structures - A retaining structure in which living plant materials, cuttings, or transplants have been integrated into the structure.

Water Quality - A term used to describe the chemical, physical and biological characteristics of water, usually in respect to its suitability for a particular purpose.

Watershed - The area contained within a divide above a specified point on a stream contributing to the supply of a stream or lake. Often times called drainage area, drainage basin or a catchment area.

Wetland - Land that is inundated by surface or ground water with a frequency sufficient to support plants and animals that depend on saturated or seasonally saturated soil conditions for growth and reproduction. These areas are commonly known as bogs, fens, marshes, wet meadows, shrub swamps and wooded swamps.

Glossary adapted from the Vermont Better Back Roads Manual, 2009

Townships in the New York Lake Champlain Watershed Counties

<p>CLINTON COUNTY</p> <ul style="list-style-type: none">- Altona- Ausable- Beekmantown- Black Brook- Champlain- Chazy- Clinton- Dannemora- Ellenburg- Mooers- Peru- Plattsburgh- Saranac- Schuyler Falls	<p>FRANKLIN COUNTY</p> <ul style="list-style-type: none">- Belmont- Brighton- Franklin- Harrietstown- Santa Clara
<p>ESSEX COUNTY</p> <ul style="list-style-type: none">- Chesterfield- Crown Point- Elizabethtown- Essex- Jay- Keene- Moriah- North Elba- North Hudson- St. Armand- Ticonderoga- Westport- Willsboro- Wilmington	<p>WARREN COUNTY</p> <ul style="list-style-type: none">- Bolton- Hague- Horicon- Lake George- Queensbury <p>WASHINGTON COUNTY</p> <ul style="list-style-type: none">- Dresden- Fort Ann- Granville- Hampton- Hartford- Hebron- Kingsbury- Putnam- Whitehall

**CHAMPLAIN WATERSHED IMPROVEMENT COALITION OF NEW YORK
EMERGENCY CONTACTS**

COUNTY EMERGENCY SERVICES DEPARTMENTS	Clinton County	(518) 565-4791
	Essex County	(518) 873-3900
	Franklin County	(518) 483-8584
	Warren County	(518) 761-6490
	Washington County	(518) 747-7520
DIG SAFELY	East Syracuse, NY	811 <u>or</u> (800) 962-7962
ENVIRONMENTAL PROTECTION AGENCY	New York, NY	(800)-424-8802
FEDERAL EMERGENCY MANAGEMENT AGENCY FEMA - Region 2	New York, NY	(212) 680-3600
NYS DEC FLOOD PROTECTION AND DAM SAFETY	Albany, NY	(518) 401-8185
NYS DEC SPILLS	Ray Brook, NY	(518) 897-1242
	Warrensburg, NY	(518) 623-1238
US ARMY CORPS OF ENGINEERS	Watervliet, NY	(518) 266-6360
US FISH AND WILDLIFE SERVICE	Cortland, NY	(607) 753-9334